



# High-Speed CAN Transceiver with Standby Mode

## TJA1042

Last Updated: Sep 21, 2023

For security on TJA1042, TJA1044, TJA1049, go to [Secure CAN TJA1152](#), for higher data rates on these devices, go to [CAN SIC TJA1462](#).

The TJA1042 high-speed CAN transceiver provides an interface between a controller area network (CAN) protocol controller and the physical two-wire CAN bus. The transceiver is designed for high-speed CAN applications in the automotive industry, providing the differential transmit and receive capability to (a microcontroller with) a CAN protocol controller.

The TJA1042 belongs to the third generation of high-speed CAN transceivers from NXP Semiconductors, offering significant improvements over first- and second-generation devices such as the TJA1040.

The TJA1042 offers improved electromagnetic compatibility (EMC) and electrostatic discharge (ESD) performance, it features ideal passive behavior to the CAN bus when the supply voltage is off, a very low-current Standby mode with bus wake-up capability, and variants with a VIO pin can be interfaced directly with microcontrollers with supply voltages from 3.3 V to 5 V.

The TJA1042 implements the CAN physical layer as defined in ISO 11898-2:2016 and SAE J2284-1 to SAE J2284-5. This implementation enables reliable communication in the CAN FD fast phase at data rates up to 5 Mbit/s. The TJA1042B and TJA1042C feature shorter propagation delay, supporting larger network topologies.

# TJA1042 Block Diagram

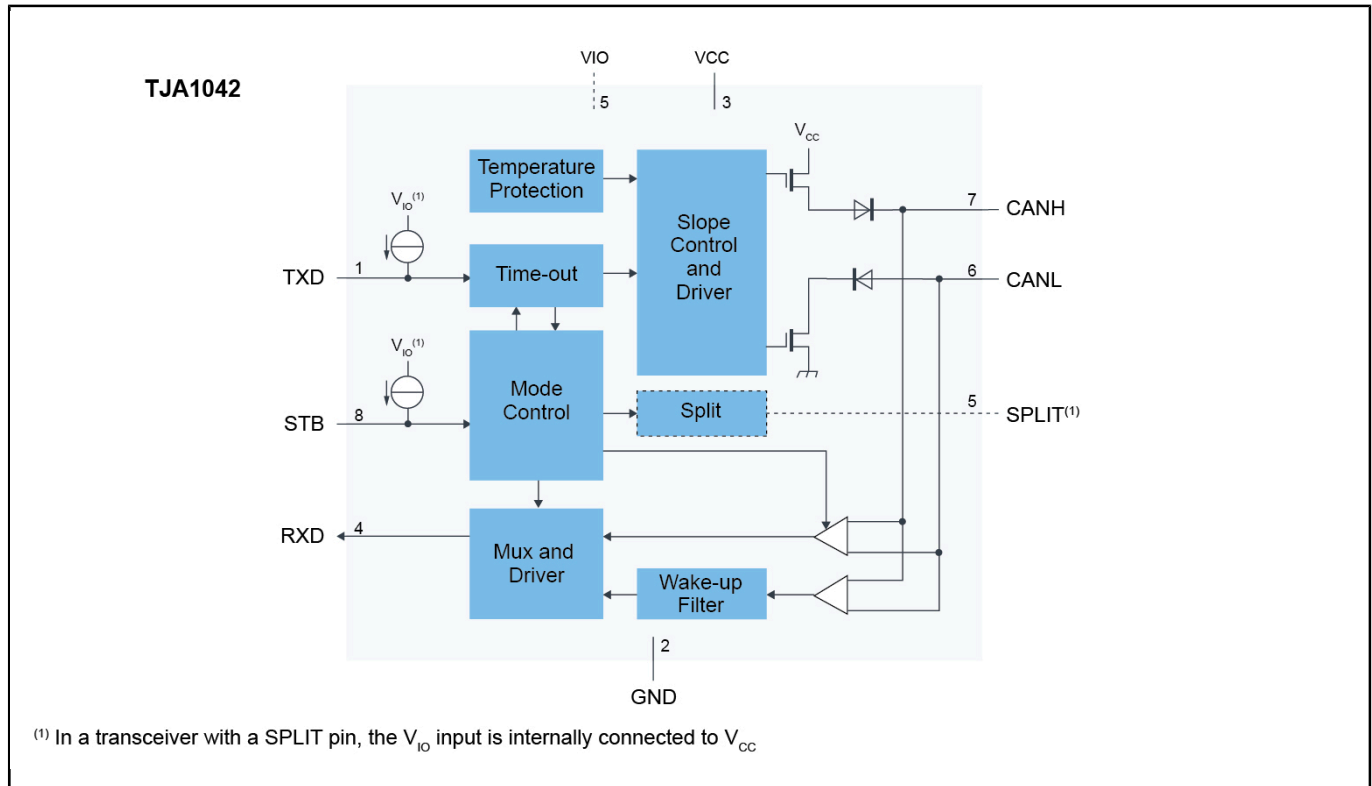

View additional information for [High-Speed CAN Transceiver with Standby Mode](#).

**Note:** The information on this document is subject to change without notice.

**www.nxp.com**

NXP and the NXP logo are trademarks of NXP B.V. All other product or service names are the property of their respective owners. The related technology may be protected by any or all of patents, copyrights, designs and trade secrets. All rights reserved. © 2024 NXP B.V.