

# Designing Touch Sensing Electrodes

## Electrical Considerations and Recommended Layout Patterns

by: Oscar Camacho and Eduardo Viramontes  
Applications Engineer  
Guadalajara, Mexico

### 1 Introduction

Touch sensing solutions, like touch panels, touch screens, and capacitive keypads are increasingly becoming a substitute for mechanical buttons or membrane keyboards. They are used in a wide range of applications from consumer products like computers, appliances, and industrial equipment to portable devices as MP3 players or cell phones. They provide human interface for entering values or setting commands into the system. For example, the numbers "1" through "9", "#", and "\*" on a common cell phone or a slider to adjust the radio volume up or down.

Migration from mechanical buttons or membrane keyboards to touch sensing solutions adds value to the applications in several ways. Touch sensing solutions do not involve mechanical parts, which eliminates chances of material wear out or corrosion due to air contact. The design can also be completely sealed from the external environment. Touch sensing solutions also reduce

### Contents

|     |   |    |
|-----|---|----|
| 1   | Introduction                                    | 1  |
| 2   | Background Information                          | 2  |
| 3   | Electrical and Layout Recommendations for Touch | 4  |
| 3.1 | Traces  | 4  |
| 3.2 | Electrodes pattern design                       | 6  |
| 3.3 | Electrode placements                            | 7  |
| 3.4 | Correct use of planes                           | 8  |
| 3.5 | Distance between electrodes                     | 10 |
| 3.6 | Virtual ground and considerations in battery    | 11 |
| 3.7 | Using capacitive films                          | 13 |
| 4   | Recommended Electrode Patterns                  | 15 |
| 4.1 | Keypads   | 15 |
|     | Single keys                                     | 15 |
|     | Multiplexed keys                                | 16 |
|     | Multiplexing for size-restricted applications   | 17 |
| 4.2 | Sliders   | 18 |
| 4.3 | Rotaries  | 20 |
| 4.4 | Keyboards                                       | 21 |
|     | Arrow keyboard                                  | 21 |
|     | Numeric, alfa-numeric, and telephone keyboards  | 22 |
| 4.5 | Touchpad  | 25 |
| 5   | Hardware checklist                              | 25 |
| 6   | Conclusions                                     | 26 |
| 7   | References                                      | 26 |
| 8   | Revision History                                | 27 |

## Background Information

overall costs by simplifying mechanical designs and material cost.

This document presents a set of guidelines for layout and placement of touch sensing circuits using Freescale capacitive touch sensing technology.

## 2 Background Information

Typically, a touch sensing solution comprises flat and non-conductive surface. This surface can be transparent (touch screens) or opaque. Users touch the surface and circuitry below process signals to determine whether a touch happened. When the system measures capacitance changes in the circuit to determine touch, the system is called a capacitive touch sensor.

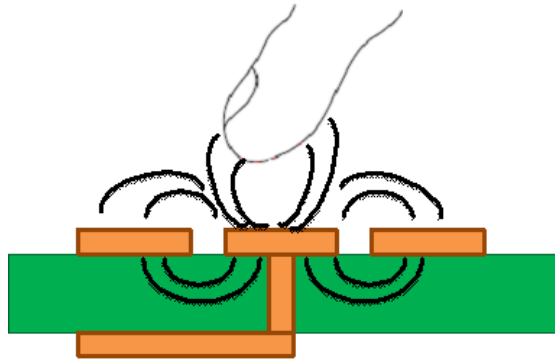
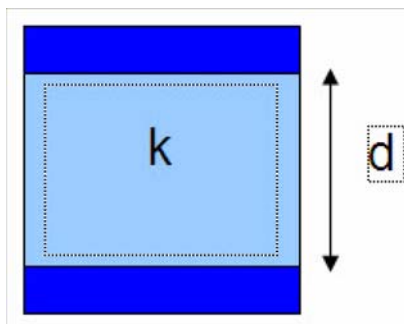

**Figure 1. Touch panel**

Freescale provides several options to implement touch sensing with different sensing approaches and ranges of operation. Each option is specially designed to cover a wide range of applications.

Depending on the product family and operational principle, sensitivity, number of inputs, and response time might change. However, correct finger touch detection relies on the sensor and the electrodes connected to it. The electrode's geometry, size, material, thickness, and layout affect touch sensing measurements. This document describes the effect of each of these characteristics in detail.

Touch sensing is based on the parallel plate capacitor model in which the variation of the capacitance  $C$  is directly proportional to the area  $A$  of two parallel plates times the dielectric constant  $k$  of the object between them. The capacitance  $C$  is inversely proportional to the distance  $d$  between the plates.



**Figure 2. Parallel plate capacitor**

$$C = (k\epsilon_0 A)/d \quad \text{Eqn. 1}$$

C is the capacitance in farads (F).

A is the area of the plates in square meter

d is the distance between the plates in meter (m)

k is the dielectric constant of the material separating the plates

$\epsilon_0$  is the permittivity of the free space ( $8.85 \times 10^{12}$  F/m)

From the parallel plate capacitor model, the following assumptions can be made:

- The object to be detected (the finger) forms one of the capacitor plates, while the touch sensing electrode forms the other plate.
- The bigger the object to be detected, the bigger is its corresponding capacitor plate area and change in capacitance.
- Larger electrodes increase capacitor plate area, and therefore can sense larger objects creating bigger capacitance changes in the presence of an object. In other words, larger electrodes are more sensitive.
- Dielectric thickness has direct impact on the sensitivity. When the object to be measured is closer to the electrode, the changes in capacitance are more. On the other hand, when the object is away from the electrode, the changes in this capacitance are less.
- Different dielectric materials change the k and therefore affect the sensitivity.
- Any parasitic capacitance in the electrodes wiring or surrounding planes adds a baseline capacitance to the system, usually seen as an offset in the sensor. If baseline capacitance is larger, the changes in the capacitance when the object approaches the touch sensing system can be difficult to detect.

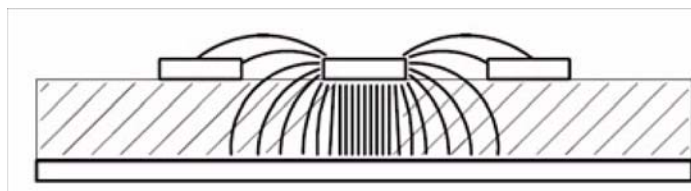

**Figure 3. Parasitic capacitance example in a two layer board**

Based on these assumptions, this document describes the best techniques for the correct electrical and layout design of a touch sensing application.

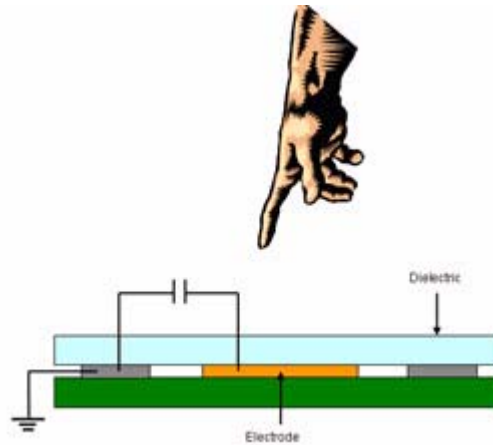

Figure 4. Basic touch sensing application

### 3 Electrical and Layout Recommendations for Touch Sensing Electrodes

This section lists basic recommendations for designing with touch sensing electrodes. These recommendations primarily apply to a printed circuit board (PCB) and FlexPCB based touch panels, but can be used for capacitive membranes or ITO membranes with minimum changes.

#### 3.1 Traces

Any electrical trace has inductance, capacitance, and resistance. The parasitic inductance and resistance depend mostly on the trace length and its corresponding loop area affecting EMI and power distribution.

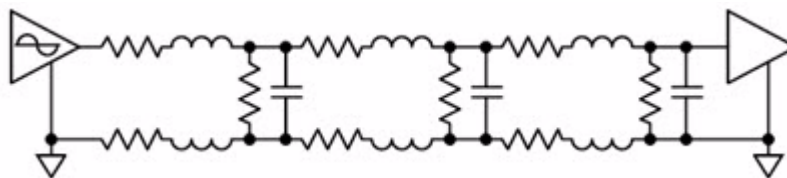

Figure 5. Electrical model of a common PCB trace

On the other hand, the distance between traces and planes commonly known as clearance, modifies the capacitive coupling of the traces. Traces running close to each other have electric field interference due to capacitive coupling.

In touch sensing applications, based on the capacitive model, any capacitive coupling is critical and might affect the touch pads sensitivity.

The following are recommendations for correctly routing the traces of capacitive electrodes.

- Width — Keep traces width as thin as possible. 5-7 mil traces are recommended. A 5 mil trace has half the capacitive coupling with the planes compared to a 10 mil trace.
- Clearance — To ensure signal integrity, leave a minimum clearance of 10 mils for the lines that run parallel to each other in the same layer, and route perpendicularly the ones running in adjacent layers. Good design practice is to keep traces separated by as much as the design allows. At the sensor's end, where typically the pitch is lower than 10 mils, a bottleneck mode connection is recommended as shown in Figure 6. The figure below is an example for maintaining adequate clearance in touch sensing traces.

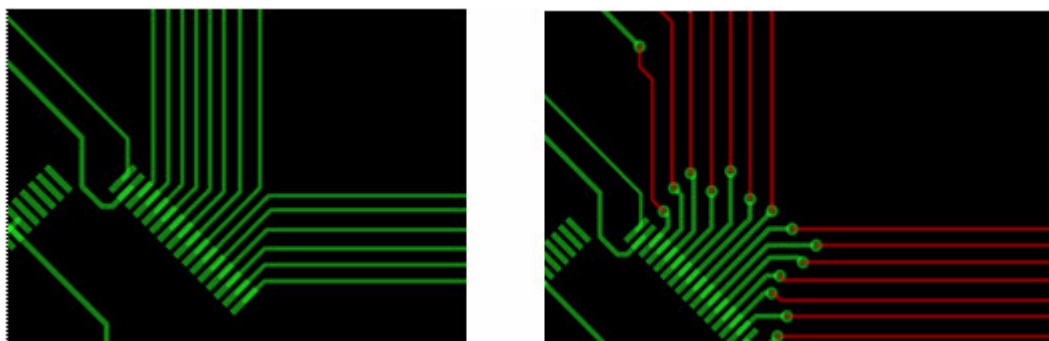

Figure 6. Bottleneck mode example

- Routing layers — In a touch sensing application, regardless of the board's stack-up, there must be no components near the touch electrodes. The opposite side contains no components, only the touch sensing electrodes are required for the touch detection. In such cases, it is recommended that touch sensor's traces are routed in a layer different to the one containing the electrodes. Also, it is recommended that components and traces not be placed right underneath the electrodes area, avoiding electrical noise to be capacitive coupled to the electrodes. Good results can still be obtained if the number of components behind the electrodes is minimized and limited to passive devices and running as few traces as possible.

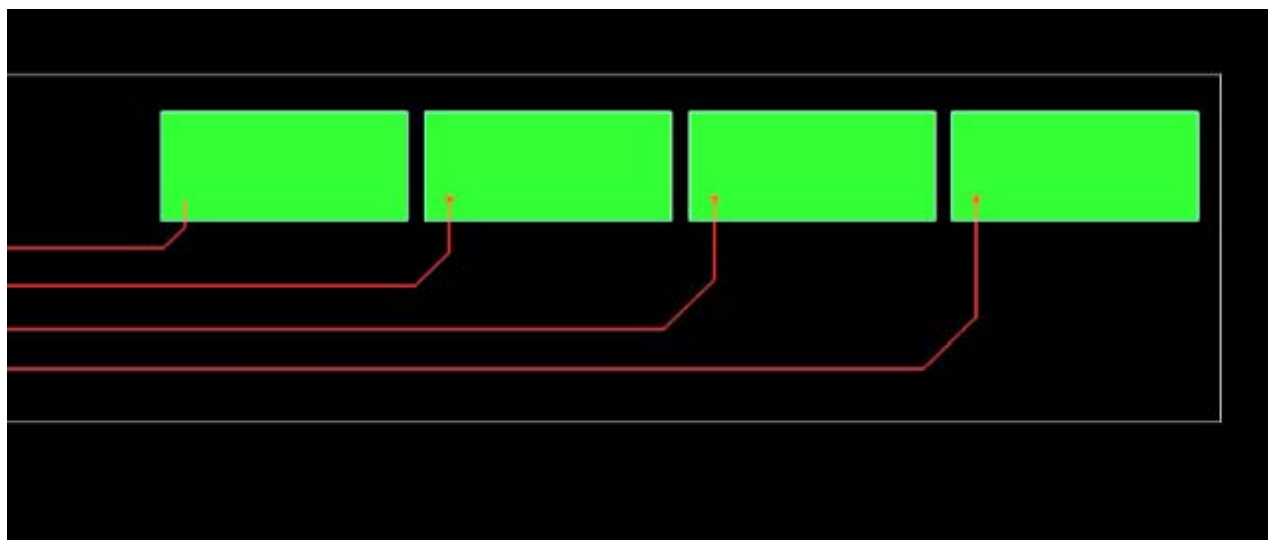

Figure 7. Touch sensing traces routing example

If the board's size restrictions do not allow a complete route free area opposite to the electrodes, its traces can run behind the pads, separated as widely as possible. The limitation is that the size of the electrode must be large compared to the total area of the trace behind the electrode, as shown in [Figure 8](#). With this constraint, you can expect good results.

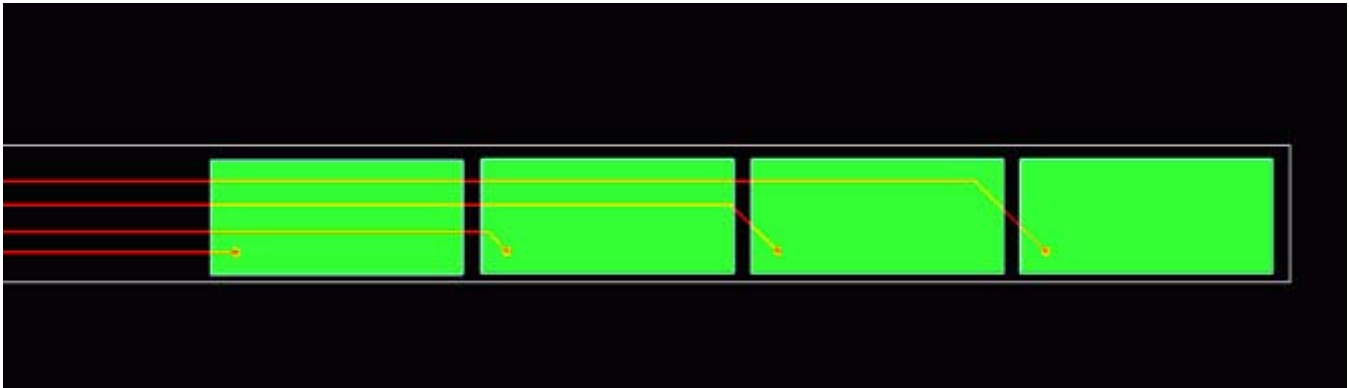

Figure 8. Routes running behind the electrodes

### 3.2 Electrodes pattern design

When routing the touch sensing electrodes, the main constraint is to reduce capacitive coupling in the electrode lines. On the other hand, electrodes are intended to catch or couple maximum capacitance to improve the system sensitivity.

For high sensitivity in the touch sensing electrodes, the shape and size of the electrode must be as similar as possible to a human finger. Single geometries, as single square, rectangle, or circle are commonly used. All these are valid as soon as the shape and area of the electrode is proximate to your finger.

[Figure 9](#) shows most common electrode patterns used to create touch sensing pads.

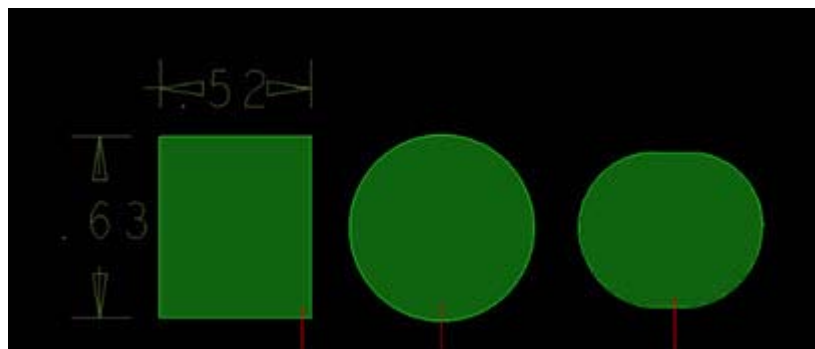

Figure 9. Touch sensing electrodes patterns

Be careful with arbitrary increases in the electrode size. Larger electrodes easily detect the presence and absence of a finger. However, in some cases, they can be more sensitive to electrical noise or undesirable surrounding objects. Moreover, increased electrode size might also overlap with the detection areas corresponding to the surrounding electrodes, resulting in erroneous detections.

It is important to keep a functional clearance between different electrodes. Functional clearance is the distance between the electrodes needed to avoid one finger touch affecting more than one electrode at a



- Two rooms placement — Two rooms for the touch sensing section must be considered, besides the placement areas or rooms for analog, RF, or digital circuitry that might be placed on the same board with the touch sensing application. One room is for the sensing circuitry microcontroller. The other room is for the electrodes. The sensing circuitry room must avoid parasitic capacitance, while electrodes room must be sensitive to capacitive coupling.
- Multi-board solutions — For many applications, a multi-boards solution is preferred. In a multi-board solution, one or more control boards contain all analog and digital circuitry for the application with the touch sensor circuitry. The solution also contains a separate touch sensing board that includes the wiring and the touch sensing electrodes. For such solutions, the touch sensing board can have different stack-ups or even use different technology as FlexPCB, membranes, ITO, or any other. For these applications, the connector between them must have low parasitic capacitance and be robust enough to avoid false contacts or series capacitance variations due to mechanical movements. For multi-board solutions, the control board is considered as the sensing circuitry room, and the touch sensing board is considered as the electrodes room. Alternatively the touch sensing board can include the sensor device, touch sensing electrodes, and communicate the touch sensing results via a digital communication interface (such as IIC). This method allows the main system processor to be offloaded from the touch sensing processing

### 3.4 Correct use of planes

The use of planes is important when designing touch sensing electrodes. A ground plane prevents coupling of external electromagnetic interference to the touch sensing electrodes, and acts as a shield for undesired electric fields. However, abusing the ground planes or simply filling open areas with ground planes might affect the sensor's sensitivity.

A ground plane is a return pad, capacitively coupled for most digital signals including the touch sensing traces. As a result, it is recommended that touch sensing traces have a good ground plane as a return pad.

Touch sensing electrodes are designed to detect electric field variations. If the fixed potential as ground is too close to the electrodes, the created parasitic capacitance affects correct human touch detection. As a result, a continuous ground plane around an electrode affects its sensitivity.

#### NOTE

The human finger has unknown impedance referenced to ground. Therefore, it is also important to provide the touch sensing system with a ground reference for closing the circuit when a finger approaches.

Following are a few recommendations and best practices for ground planes usage.

- Do not use filled ground planes underneath electrodes area — In case a ground plane is needed, make sure it is not filled. If the plane underneath the electrode is completely (100%) filled, the total capacitive coupling from the ground plane is much higher than the one created by a finger, adding a large offset to the capacitive measurement. It makes the detection of a valid finger touch more difficult.
- Use X-hatch pattern underneath the electrodes area — Instead of arbitrarily filling empty areas with ground, an X-hatch pattern is recommended, especially in the opposite side of the electrodes. When using the X-hatch pattern in the ground plane, the total capacitive area in parallel with the



electrode is reduced while filtering most of the electrical noise entering the backside of the panel. The X-hatch pattern recommended is round 20%, which defines the line width as minimum as possible with the line spacing proximate to 50 mils.

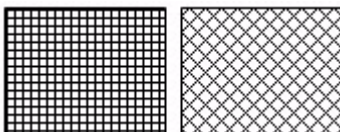

Figure 11. X-hatch Pattern

- Use filled ground planes for analog and digital circuitry — For the electrodes room, an x-hatch pattern or no ground plane is recommended to avoid adding load capacitance to the capacitive electrodes. On the other hand, a 100% filled plane helps digital circuitry EMI and signal integrity. It is recommended to have digital and analog circuitry with these filled planes. The electrode wires can be considered as digital traces, therefore it is recommended to reference them to a completely filled ground plane during their way to the electrodes. Figure 12 shows an example of the two ground patterns existing in an application.

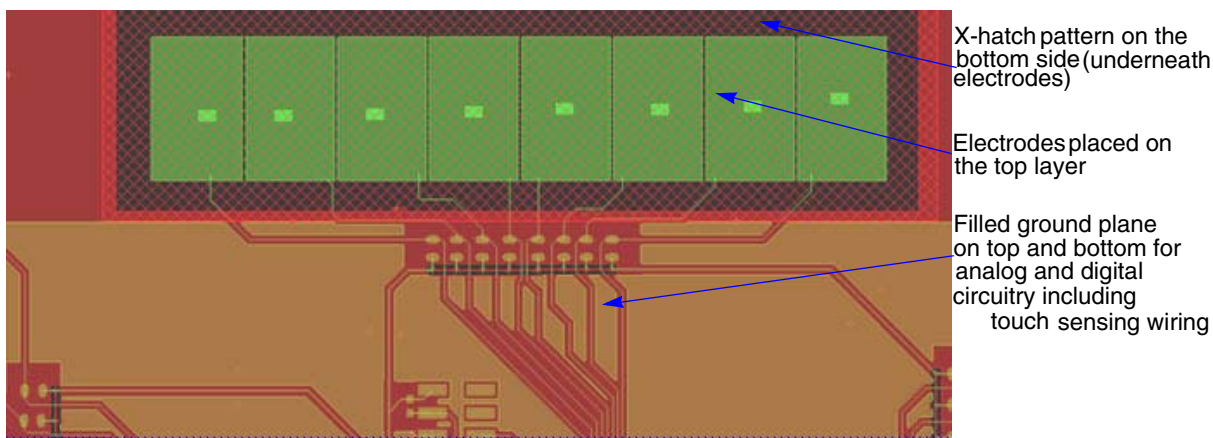

Figure 12. Ground planes correct use

- When there is enough space between electrodes it is recommended to also include a grounded hatch between the electrodes. This provides additional noise shielding and reference. A hatch is preferred over a continuous plane for the same reason as above, to avoid adding too much parasitic capacitance. Because the top hatch uses less area, it is acceptable to use a denser hatch, a 20 to 30% fill is recommended. Notice that when filling both layers (or top layer in a single layer board) with ground hatch, traces still need to get to the electrode. Routing in a different layer than the electrodes is still recommended, use a clearance of about the same width as the traces to isolate the ground hatch from the trace. For example, for a 5 mil trace, use 5 mils clearance on either side of the trace. Figure 16 shows the idea of hatch on the top and bottom of electrodes.

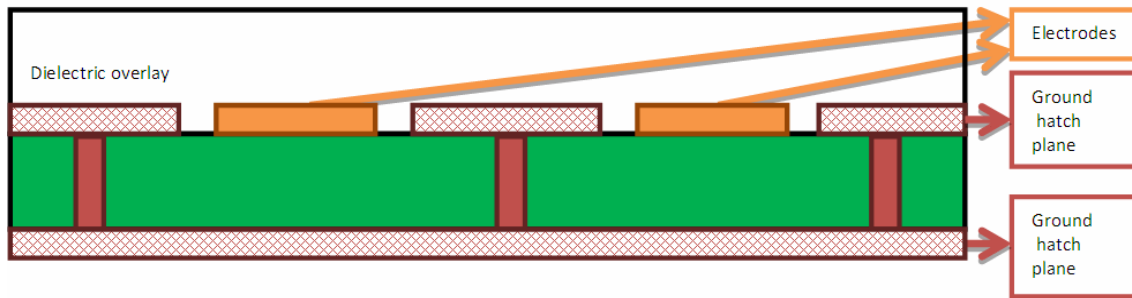

Figure 13. Example of ground hatch on top and bottom planes

### 3.5 Distance between electrodes

Electrodes may or may not be placed near each other. In an ideal keypad, where individual electrodes are used for each key, electrodes should be placed as far away from each other as possible. This helps with electrode crosstalk (not to be confused with trace crosstalk). Electrode crosstalk has to do with a single finger touch affecting two or more surrounding electrodes. This crosstalk is directly affected by distance between electrodes as well as dielectric (the touch surface) height. Figure 4 shows this.

Based on these assumptions, this document describes the best techniques for the correct electrical and layout design of a touch sensing application.

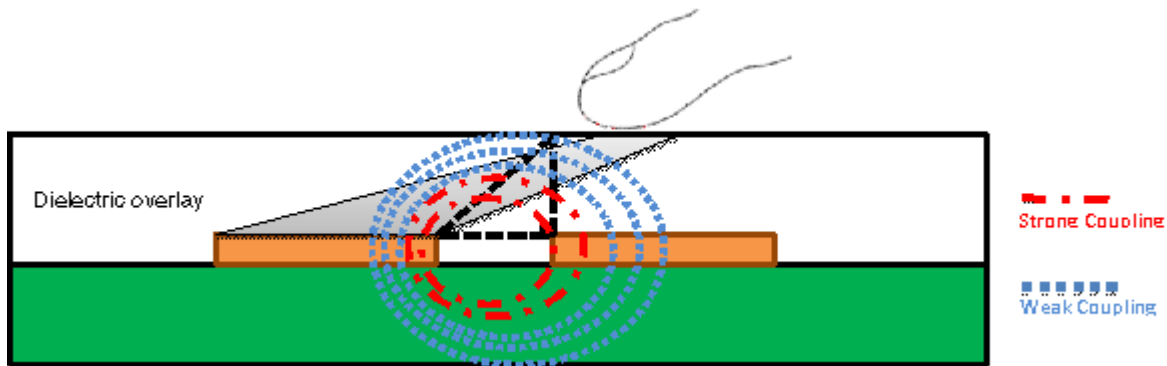
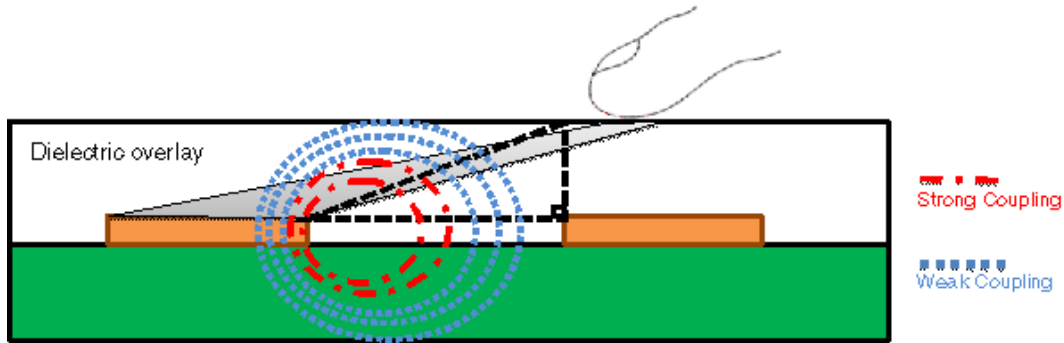

Figure 14. Strong field coupling between two electrodes

As can be seen, the distance between the two electrodes allows for electric fields to interact strongly, so even when touching one electrode, capacitance in surrounding electrodes will also be affected. The following figure shows a case where electrodes are so far apart, no strong capacitive coupling occurs.



**Figure 15. Weak field coupling between two electrodes due to larger separation**

Figure 15 is the ideal case for keypads where a single electrode-per-key is desired. A simple criteria to follow is to have electrodes separated 2 to 3 times as much as the dielectric thickness to be used. For example, if a 3 mm glass is used, then electrodes have between 6 mm and 9 mm separation. This is the ideal but it's not a rule. If keys need to be closer together, then the best option is to have a test prototype as close to the actual operating conditions as possible and to use a graphical debugging tool (such as FreeMASTER, as used by the Freescale Touch Sensing Software Library) to determine if the levels of capacitance are above the signal-to-noise and the parasitic capacitance change detected in the surrounding electrodes will not be detected as a touch. Notice that this is not a hard requirement, the Touch Sensing Software library (TSS) can select the highest value electrode and only report that as touched. It can be configured to report any number of touched electrodes at the same time, so in cases where there need to be several electrodes tightly together, and the above criteria can not be met, the library is able to help. Still, it is ideal to keep electrodes as separated as the application allows.

- Also notice that there are multiplexed keypads that actually need electrodes to be closer together, this is discussed in detail in another section.

### 3.6 Virtual ground and considerations in battery operated applications

In most touch sensing applications the human finger is considered as one of the capacitor plates, while the conductive electrode is the complementary plate. This assumption is valid only if the human and the touch sensing device use the same potential reference (see Figure 16), that is, only when the touch sensing device is physically grounded. An example of this user scenario is when a human is standing on the floor of their house touching the panel of an appliance that is physically grounded.

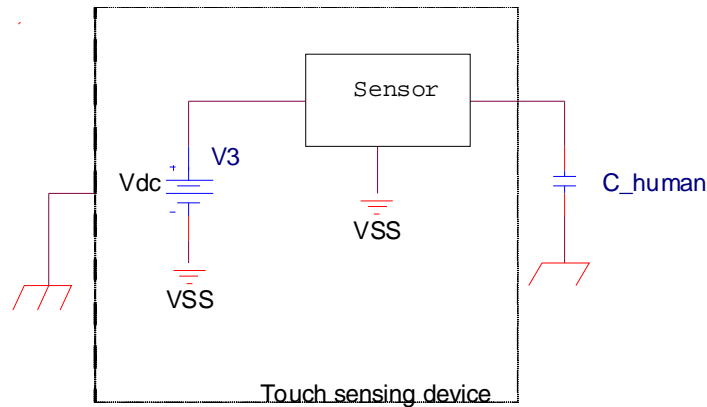

**Figure 16. Physically grounded device**

The human finger creates a virtual ground to the system and can be used as one of the capacitor's plates. In battery operated applications or in applications where the touch sensing device has no reference to the physical ground, the human being might not be at the same potential reference as the touch sensing application. This results in a capacitance variation from touch to touch, consequently with a difficulty to detect the human touch. This issue is what is called floating ground or loss of virtual ground.

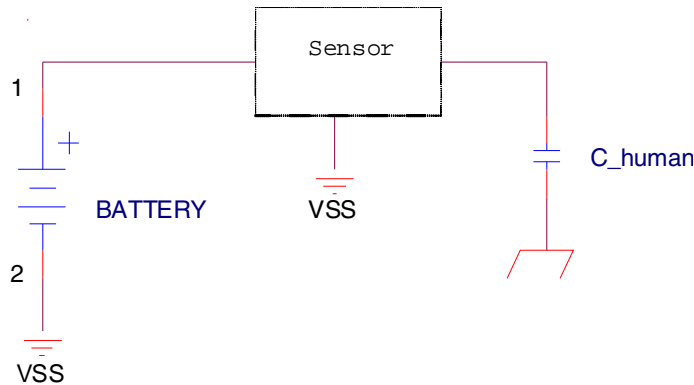

**Figure 17. Floating ground condition**

In battery operated applications, the human finger does not have the same potential reference as the sensor's ground.

To avoid issues with a floating ground, a proper physical ground connection of the touch sensing device is recommended.

In portable or battery operated applications, having a human ground reference is not always possible, in such cases it is necessary to use the human conductivity characteristics to modify the electrical field created between the electrode and the system ground. Therefore, the human finger, instead of working as one of the conductive plates of the capacitor becomes a dielectric constant modifier. To accomplish this task, it is necessary to have a fixed potential (ground) close to the electrodes area, an electric field is then created between the electrode and ground. This electric field is modified as the human finger approaches.

Using a ground ring, having a ground plane around the electrodes, or having ground interleaved in the electrodes area can be used as a solution.

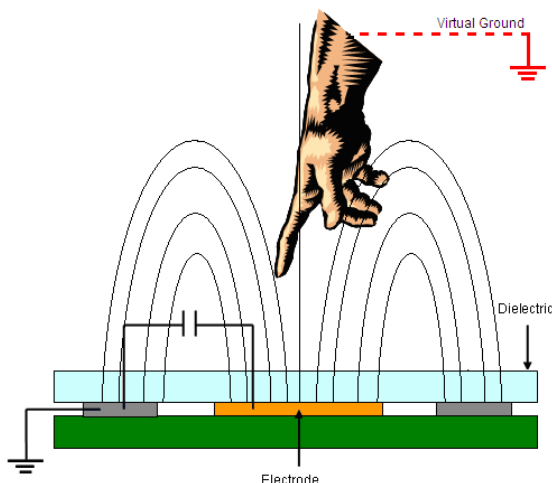

**Figure 18. Human finger acting as electric field modifier, instead of one of the capacitor plates**

When having multiplexed electrodes, the non-selected electrodes provide the required fixed potential nearby scanned electrode, solving the floating ground issue naturally. Using more than one electrode per key can be used as solution in battery operated applications.

### 3.7 Using capacitive films

The printed circuit board (PCB) is one of the most common solutions for implementing touch sensing panels, however this solution limits the final application in terms of curvatures and irregularities on its surface. Applications developed with PCB must be plane and flat to ensure manufacturability, reliability, and an adequate cost.

The FlexPCB and ITO (Indium Tin Oxide) can adapt to curvatures or irregular surfaces in the panel due to their inherent flexibility, however, the solution tends to be more expensive compared with flat panels that use printed circuit boards.

Capacitive films are a cost effective and reliable solution for implementing flexible touch sensing solutions that adapt to curvatures on the surface of the panel. The nature of the capacitive film is the same used for creating mechanical keyboards, also known as membrane switches. A touch panel using capacitive films provide many advantages, for example:

- Flexibility—Allowing it to conform to curved surfaces.
- It can be adhered directly to the rear of the touch surface with no air-gaps between the touch sensing electrodes and the dielectric material.
- It is ultra-thin in design.
- The assembly is sealed from moisture or contaminants
- The flex tail is integrated with the circuit, so it does not require a separate interconnect

- No moving parts for a long life.

Capacitive films are not limited to one conductive layer. Multilayer designs and via holes can be also implemented, improving the reliability in terms of signal integrity and shielding. For example, the stack-up for a capacitive films is shown in [Figure 19](#).

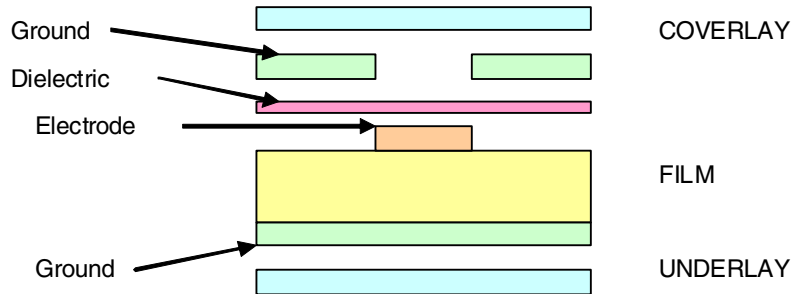

**Figure 19. Capacitive film stack-up example using three conductive layers**

Most PCB design considerations apply to capacitive films, however there are some differences that must be taken into account:

- The conductive ink used in most capacitive films is controlled by a process called screen printing. This maximizes conductivity, flexibility, printability, and adhesion to various substrates used in the manufacture of flexible circuits. However, the resistivity of the ink used by capacitive films is usually larger than the copper resistivity used for the PCB. The resistivity of the ink ranges around 0.5 ohms per inch of the trace. This has an impact in the sensitivity of the touch sensing electrodes.
- The multi-layered circuit can be implemented, using pairs is not necessary, odd number of conductive materials can be used.
- The polyester material, used as the core film material is heat-stabilized polyester that can be as thin as 0.005". Thicker films can also be manufactured to accommodate various ZIF or low insertion force connectors.
- Via holes can be used to connect layers of conductive materials, however, it is not recommended to abuse their use, this might impact film cost.
- The traces can not be as thin as in PCBs, film manufacturers recommend a minimum of 0.018" trace width and 0.020" spacing; this must be taken into account specially because of its impact on parasitic or baseline capacitance.
- The use of carbon inks is recommended on top of exposed silver traces at contact points on the film tail to reduce silver oxidation.
- To add value, surface mount devices such as LEDs can be mounted on flexible screen printed circuits. However, it must have a conductive adhesive and be encapsulated to ensure reliability. After the LED is mounted, take care to note that twisting or any rough handling may break the connection. It is recommended that the screen printed circuit with LED or any other SMD remain on a flat surface.
- Interconnect can be female, male, zero, or a low insertion force connector, with a variety of pitches. Locking type connectors can also be accommodated.
- The flexible tail should not be creased, but bending around a small radius is acceptable.

## 4 Recommended Electrode Patterns

With the trend and demand for miniaturizing portable media devices and consumer electronics, new techniques and design strategies must be explored to accomplish the desired sensitivity and robustness of the touch panels without sacrificing manufacturability and cost.

This section proposes some of the geometries to achieve common functions of a touch panel and touch screen applications as keys, sliders, rotary switches, and keyboards.

### 4.1 Keypads

As described in [Section 3.2, “Electrodes pattern design,”](#) simple shapes as circles, rectangles, or ovals with a size similar to the object to be detected are a good starting point for designing touch sensing applications. However, based on an electrode's function, its geometry can be modified to achieve better results or improve sensitivity. These shape and size modifications are described in the following sections of this document.

Depending on the number of channels available in the sensor and many times on the panel key arrangements, logical combinations of electrodes pressed at the same time can be used. The principle of logically combined electrodes to validate a touch is typically known as multiplexing. If a key uses only one touch sensing channel, it is called a single key. If two or more touch sensing channels are used to determine a valid key, they are called multiplexed keys.

#### 4.1.1 Single keys

To maximize the electrodes area from the capacitor plates, it is recommended that the size of the electrode be similar to a human finger (0.6 in. × 0.6 in. is considered a good size).

[Figure 20](#) shows some examples of single keys.

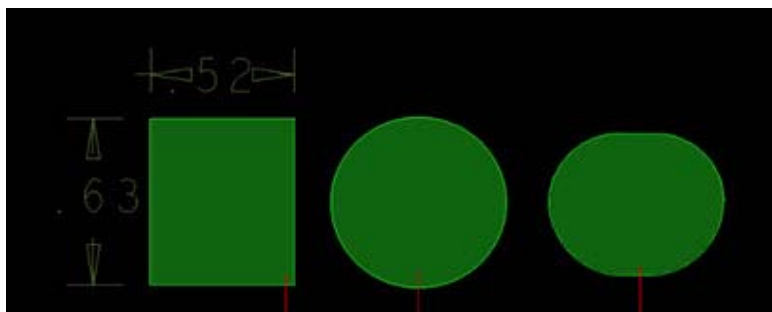

**Figure 20. Layout patterns for single keys**

This approach is valid and useful when there are no size restrictions of the panel. Consequently, when there is a distance between the keys, allow a finger touch to modify only one electrode at a time. Notice that rounded shapes are always preferred above squared shapes. Sharp corners exhibit a random dispersion of charges, opposed to rounded patterns where charges are evenly distributed along the border.

### 4.1.2 Multiplexed keys

When the number of keys exceed the available sensor channels, multiplexing or logical combinations can be created. Consequently, the detection of a valid key is not directly the change in capacitance of a single electrode but of two or more electrodes at the same time.

**NOTE**

When multiplexing a key, the contact area for each electrode is reduced at least to half. Therefore, sensitivity is reduced in the same proportion, requiring slightly more complex software to determine a valid key.

Figure 21 shows the recommended geometry for multiplexing a key. The preferable size is the size of a finger. This geometry is preferred because the area of the key is maximized. In other words, a small amount of area is lost when merging the two electrodes together. In addition, the geometry accepts that if finger touch shifts a little bit horizontally or vertically the area of the key, the two electrodes that create the logical combination are affected in the same proportion.

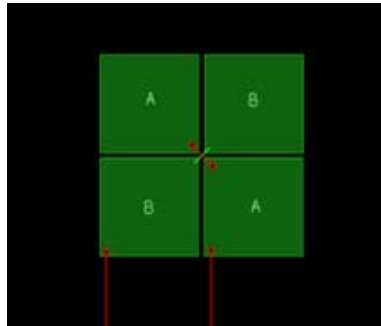

Figure 21. Example of a multiplexed key

Figure 22 shows the multiplexing technique used, arraying several keys in an X-Y manner to form a keyboard.



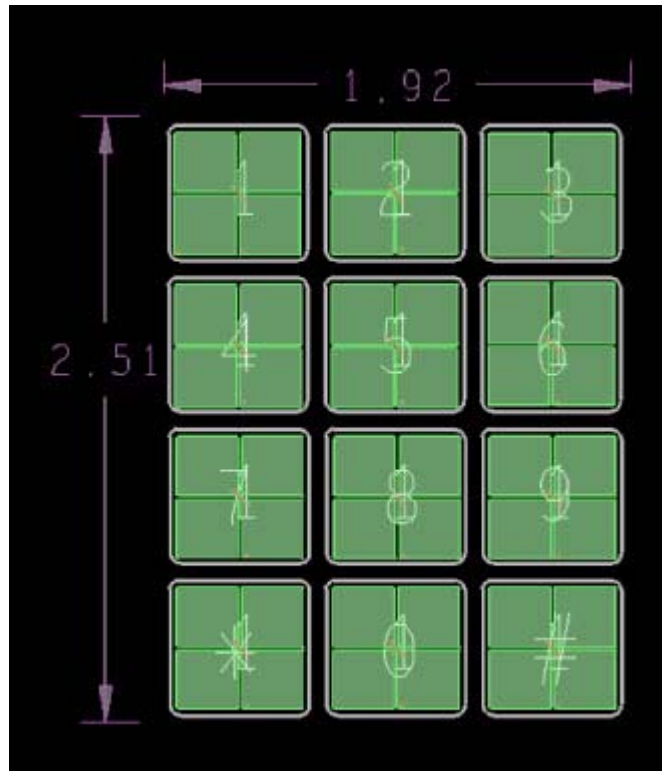

Figure 22. Capacitive keyboard using multiplexed keys

### 4.1.3 Multiplexing for size-restricted applications

Touch sensing applications restricted in size are common to almost all applications. A size-restricted touch application is recommended when the key area is smaller than a finger's transversal area or when keys are so close to each other that multiple keys are detected when a key is touched.

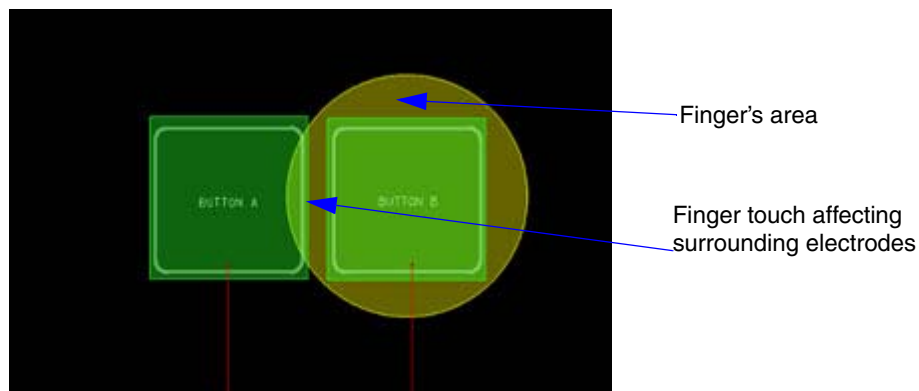

Figure 23. Keys arrangement in a size-restricted application

With such restrictions, software routines and algorithms are implemented to distinguish valid touches based on the analog value of the capacitive coupling at each of the affected keys.

## Recommended Electrode Patterns

Reducing the electrode size does not address the problem in most cases because electrode sensitivity is reduced. Varying the dielectric thickness or material is not an option either. The effect of reducing the electrode size cannot be compensated with dielectric modifications.

In such cases, it is recommended to multiplex keys in a different way by using some touch sensing electrodes as common electrodes for two or more keys. An example is shown in [Figure 24](#).

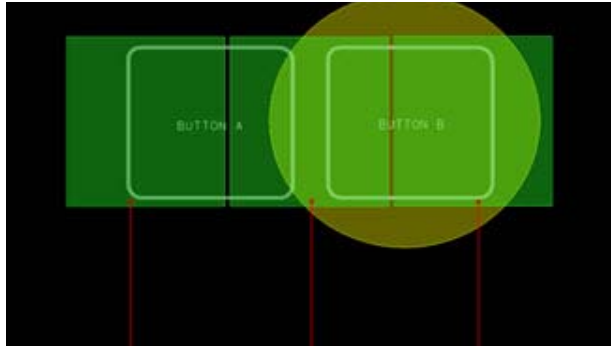

**Figure 24. Multiplexing in size-restricted areas**

To understand this principle, compare [Figure 23](#) and [Figure 24](#). Both figures show the same keypad in a size-restricted application, with Button A and Button B smaller than a finger's touch area (highlighted in yellow) and where both buttons are so close that interference cannot be avoided. In the first approach, [Figure 23](#), pressing Button B also affects the Button A area and vice versa. In this scenario, when a key is pressed, the opposite one also changes its capacitive value, making it difficult to distinguish which one is valid. [Figure 24](#) uses a common electrode for both keys with a multiplexing technique. In this scenario, pressing the Button B affects the logical combination of the two electrodes that form Button B without interfering with the electrodes that form Button A.

With these logical combinations, distinguishing the valid touch of a key is easier. The capacitive coupling of a finger touch for both electrodes forming a logical combination is practically equal.

This multiplexing technique is not only valid for keys, but also recommended for sliders, rotaries, and keyboards with size restrictions. This document describes the specific details for each configuration in the sections that follow.

## 4.2 Sliders

Sliders are the touch sensing representation of a potentiometer and are interpreted as an analog value of user input touch position. Sliders are typically used for scrolling menus or to increase and decrease the value of a specific user parameter, for example, volume in an audio application or temperature in an air condition module.

Unlike common keys, slider information not only uses a pressed and un-pressed condition, but also depending on the application and the user scenario, uses touch direction and scrolling speed to interpret input information.

The software logic for sliders is more complex than single key logic. It needs to distinguish where the first touch took place, the direction in which the finger is moving, and the speed at which finger is moving along the slider.

From the hardware perspective, the layout design for a slider is simple. The example in [Figure 25](#) shows a basic slider with 8 steps resolution. Its construction requires eight touch sensing electrodes (E1 to E8) arranged horizontally together to form the slider. For this specific slider, application software interprets the information from each touch sensing electrode channels and decodes whether electrodes are logically pressed coming from left to right (E1 to E8) or in the opposite direction (E8 to E1).

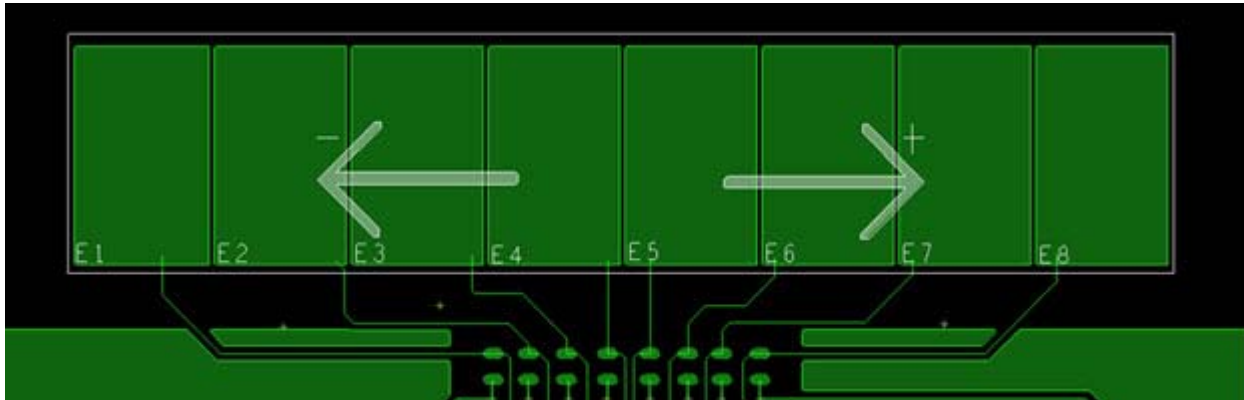

Figure 25. Basic slider pattern

**NOTE**

In [Figure 25](#), with the slider visible, 15 step resolutions can be accomplished if the multiplexing principle is used by allowing the logical combinations of two electrodes pressed at the same time. For example, pressing the area between E5 and E6 could give us an intermediate step if we allow both electrodes to be pressed at the same time. This technique is called microstepping. If microstepping is used in the slider example in [Figure 25](#), the resolution will contain 15 steps resulting from combinations E1, E1E2, E2, E2E3, ... , E7E8, and E8.

[Figure 26](#) shows another example where microstepping is implemented. In this case, microstepping is implemented directly in the electrodes layout. Therefore, all touch sensing electrodes are affected proportionally to the finger's position at each electrode. This slider arrangement has a higher resolution than the one in the previous example. However, it is recommended only when the sensitivity of the panel or from the sensor itself is enough to have an analog measurement of the electrode's capacitive coupling.

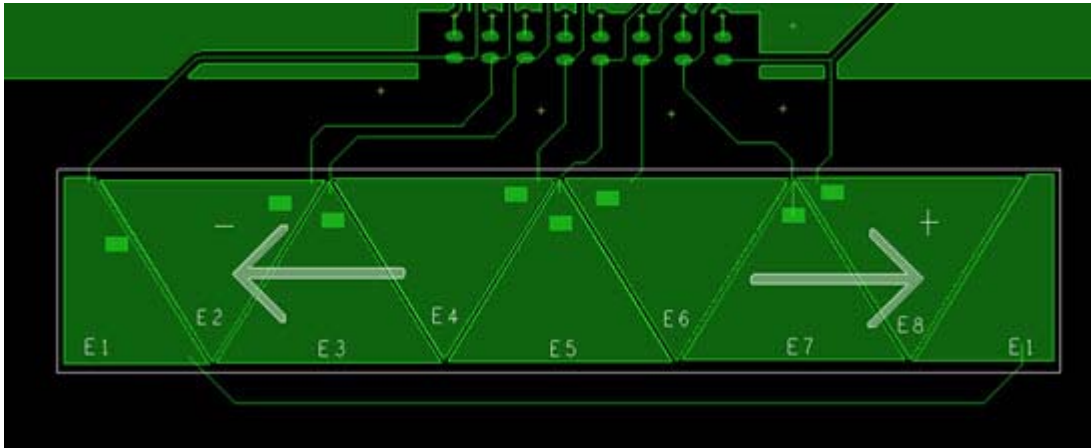

Figure 26. Slider with microstepping

**NOTE**

When using this topology, ensure that the height of the electrodes is not that large so that finger movement in the perpendicular way could be detected as displacement along the slider.

### 4.3 Rotaries

The rotary in touch sensing applications is typically a substitute to a mechanical rotary switch. The principle of operation is similar to a slider. The main difference is its rounded design forming a closed circle. Rotaries are useful for scrolling large menus or provide user inputs with wide range of values. In some cases, the rotary might include a central button to accept or validate the values modified by the rotary itself.

Like sliders, the input value from the rotary depends on the logical order at which the capacitive sensing electrodes are coupled by a finger. Depending on the direction at which the electrodes are logically detected, whether ascendant or descendant, the information is interpreted as clockwise or counter-clockwise scrolling. Also, microstepping can be implemented for increasing rotary resolution.

Figure 27 shows the recommended touch sensing electrodes array for a rotary. This simple topology also includes a center button, optional for some applications.

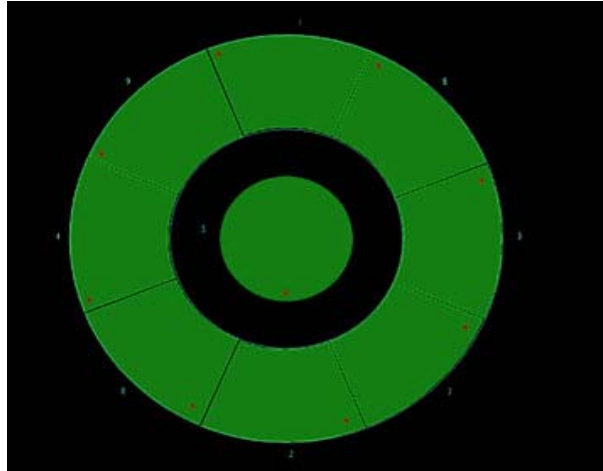

Figure 27. Recommended layout of a rotary

#### NOTE

For relative control where absolute position is not a requirement, the topology can be simplified for using only three electrodes arranged in 1-2-3-1-2-3-1-2-3 fashion giving desired resolution while reducing the number or required electrode channels.

## 4.4 Keyboards

Keyboards are used in a wide range of applications, from cellular phones and PDAs to personal computers, point of sales, and many other medical appliances, and industrial applications.

Some keyboard arrangements are common to different applications. For example, the common telephone keypad that contains keys for numbers "0" to "9", "#", and "\*" in a 3 by 4 array can be found in almost every telephone, cellular phone, and other applications such as ATMs or fuel dispensers.

Although the same keyboard arrangement is used, most of the times, for the same functions or purposes, the layout for each keyboard might change depending on the keys size, distance between the keys, and the thickness of the dielectric. This section describes a few layout patterns recommended by Freescale.

### 4.4.1 Arrow keyboard

The arrow keyboard typically consists of five keys; a central key surrounded by an arrow key at each side. See [Figure 28](#).



Figure 28. Example of an arrow keyboard

In this arrangement, the arrow keys are closely located at the ENTER or OK key. Using touch sensing with this restriction results in the detection of the ENTER key when an arrow key is approached by a finger. In addition, attempting to touch the central button also affects the surrounding keys. It is a size-restricted application, therefore it is recommended to use a multiplexing technique as described in [Section 4.1.3, “Multiplexing for size-restricted applications.”](#)

Figure 29 shows the recommended layout pattern for the arrow keyboards. As shown in [Figure 29](#), pressing any of the arrows on the edges affects its corresponding electrode on the edge and also an electrode common to all keys, without interfering with the electrode at the center that corresponds to the ENTER key. If the ENTER key is pressed and the finger area overlaps with the arrow keys, the central electrode and the electrode common to all keys are affected.

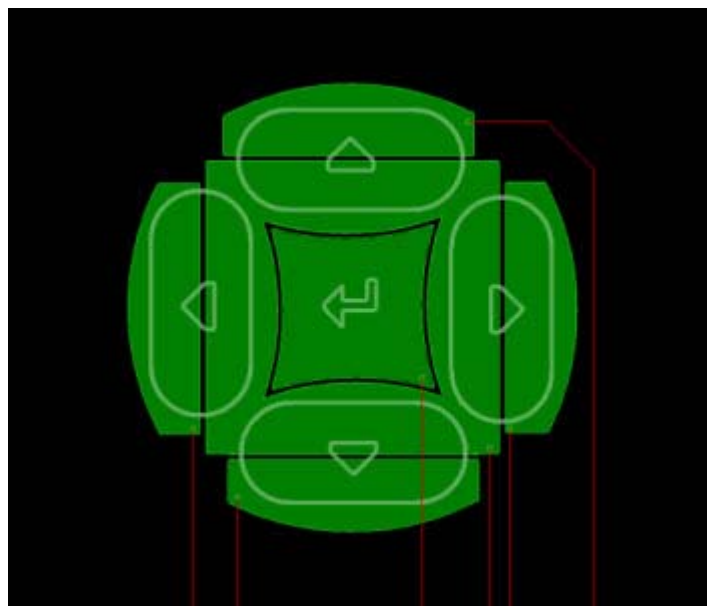

Figure 29. Layout pattern for the arrow keyboards

#### 4.4.2 Numeric, alfa-numeric, and telephone keyboards

The numeric, alfa-numeric, and telephone keyboards are used as the main source to enter values or commands to an embedded application. All these keyboards typically have an X – Y or rows-columns

arrangement. For example, the telephone keyboard in [Figure 30](#), is arranged in three columns and four rows.



**Figure 30. Common telephone keyboard array**

There is a wide range of keyboards with variations in the row and column count, size, materials, and dielectric characteristics. Freescale has a patented technique for the design of touch sensing electrodes in capacitive keyboards. This technique applies to almost every capacitive keyboard. This document describes the application of the technique to a 3 x 4 telephone keyboard.

As described earlier, in size-restricted applications where the size of the keys is smaller than a finger area and the proximity between keys is such that multiple keys are detected when a key is touched, multiplexing techniques is recommended to validate the pressed key.

The Freescale patented technique uses the multiplexing technique to avoid interference of keys pressed at the same time. It also improves keypad sensitivity by increasing the effective capacitive area created between the finger and the electrodes. This technique also reduces the number of capacitive sensor channels that are required if dedicated touch sensing electrodes are used for each key.

In the Freescale patented technique, [Figure 31](#), the capacitive electrodes are arranged on a keyboard, therefore each key is detected with a combination of two capacitive electrodes. In this case, each capacitive electrode is also used by adjacent keys vertically and horizontally. This combination of two electrodes per key ensures that the shared or common capacitive electrode is used by four keys at the same time.

This technique increases the effective capacitive area of the keys, reduces the interference between the keys, and improves the sensitivity and signal-to-noise ratio in the keyboard. With this arrangement, the total area for each electrode doubles the size of a single electrode per pad to get the flexibility of multiplexing electrodes and to increase the logical combinations.

[Figure 31](#) shows the application of the Freescale patented technique to a common telephone keyboard.



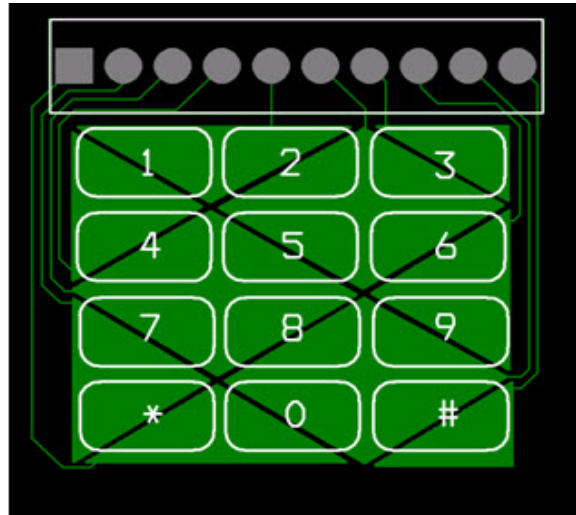
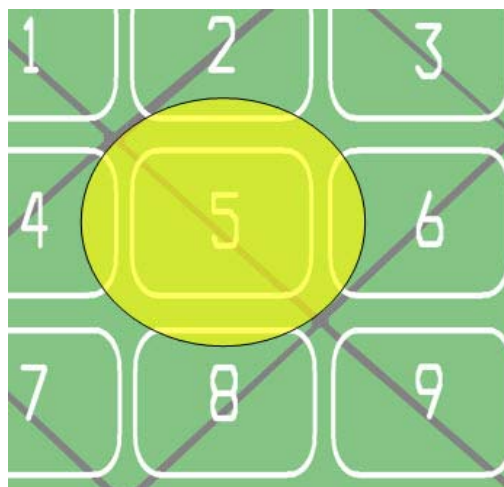

**Figure 31. Freescale patented keyboard arrangement applied to a common telephone keyboard**

Different geometries and shapes can be used to comply with the basic rules described above. However, the rhomboid or diamond is the most suitable shape because it ensures that each key uses two electrodes with exactly the same area per key. It also ensures that each surrounding key contains the same electrode as part of its multiplexed combination. Each rhomboid is created by a single electrode and shared by four keys at the same time.

Since all surrounding keys in the key pad share common electrodes, touching partially surrounding keys results in even better capacitive detection of the desired combination. This configuration is ideal for scenarios where keys are smaller than a finger size and so close that partial detection by surrounding keys cannot be avoided.

Figure 32 shows an example. Consider you want to press and detect key #5. Using a common single or multiplexed configuration, a change in keys #2, #4, #6, and #8 will be also detected. Therefore, algorithms to distinguish a valid key based on the capacitance value must be implemented to determine valid key pressed.



**Figure 32. Keyboards with Freescale patented technique**



With the Freescale patented technique, if key #5 is pressed again while partially touching keys #2, #4, #6, and #8, the result will be an accurate detection of the two electrodes that form key #5.

## 4.5 Touchpad

The touchpad is a two-dimensional input interface that must be able to detect touch and release conditions and vertical and horizontal sliding in a specific area. Touchpads are not limited to personal computers. Nowadays PDAs, appliances, and industrial applications use a touchpad as a friendly and customizable user interface.

The topology that Freescale proposes for implementing a touchpad is in an X–Y or row–column fashion, as illustrated in [Figure 33](#). Two layers of conductive materials are needed to accomplish the interleaving of the rows and the columns for a finger tip.

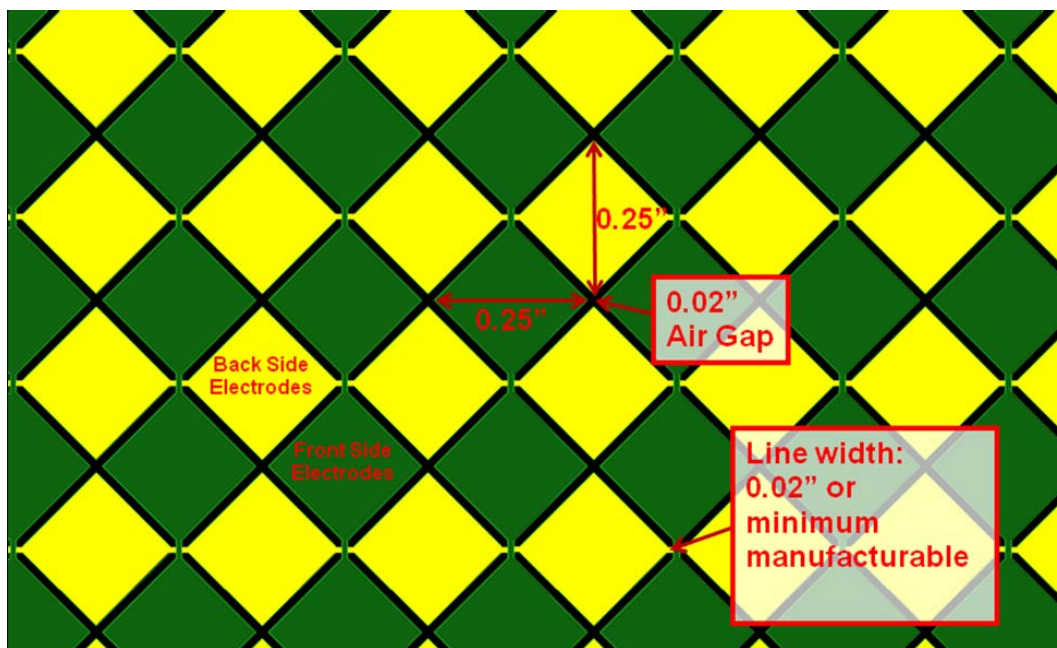

Figure 33. Touchpad design example

The decoding for this type of interfaces is the combination of two sliders. The horizontal one created by sliding a finger through the different columns, and the vertical slider created when a finger slides through the rows. In the same manner, a touch and release condition in a certain region of the touchpad is detected by the combination of one row and one column touched at a time.

Resolution can be increased by reducing the size of the diamonds. However, depending on thickness and dielectric constant of the overlay on top of the touchpad, the electrodes sensitivity may be too minimal to detect acceptable touches above the signal-to-noise ratio.

## 5 Hardware checklist

The following is a checklist based on the recommendations in this application note. Before having a board, film, ITO, and the touch sensing board made, make sure the design follows all or most of these rules:

## Conclusions

- GND return path is provided per specifications (GND hatch below or at least around the electrode keypad).
- When using GPIO, input capture or keyboard interrupt pins as inputs, and pull-ups as close to the MCU as possible.
- When using GPIO, input capture or keyboard interrupt make sure pins are actually able to do input and output, input-only pins do not work.
- Recommended pull-up value from 500 k $\Omega$  to 1.5 M $\Omega$ . Above 1.5 M $\Omega$ , the current going through pins is so small that it is similar to the pin leakage current, this can affect the actual measurement. Below 500 k $\Omega$  the RC constant is so fast the MCU can not count fast enough to get a good signal-to-noise ratio.
- No pull-ups present in TSI-enabled (touch sensing input module) pins.
- Series resistors in cases where series current protection is desired should be lower than 100  $\Omega$ .
- Make sure no signals that are not touch sensing run parallel to the touch sensing signals. If signals need to go through the touch sensing traces, have them go in a different layer and perpendicular. Make sure to fill in ground between groups of traces (analog, digital, and touch), if possible, fill in ground between touch sensing traces.
- Traces as thin as the PCB or film technology will allow.
- Short traces (< 5 in. from electrode to MCU, ideally < 2 in.)
- Electrode shape corners as rounded as the layout will allow.

## 6 Conclusions

This application note describes the basic principles and electrical implications associated with touch sensing electrodes layout.

It also presents solutions for the most common touch sensing topologies including keys, sliders, rotary switches, and different keyboard arrangements.

Freescale provides a wide range of products supporting touch sensing, from the Analog Electric field sensors and ASICs to embedded software libraries portable to different platforms. For further information about touch sensing applications and Freescale products that support this application, refer to the links in [Section 7, “References.”](#)

## 7 References

To read more about touch sensing applications, refer to:

- [www.freescale.com/touchsensing](http://www.freescale.com/touchsensing)

## 8 Revision History

Table 1. Revision History

| Revision Number | Revision Date  | Description of Changes  |
|-----------------|----------------|---|
| Rev. 1          | June 2009      | Launch Release  |
| Rev. 2          | September 2009 | All expressions referring to “proximity” within the document be changed to “touch.”                       |
| Rev. 3          | September 2010 | Added Sections 3.6 and 4.5. Updated Section 3.6.  |
| Rev. 4          | July 2011      | Updated Sections 1, 2, 3.1, 3.3, and updated fig 1, and added figure 10, 13, 15. Added Sections 3.5 and 5 |

**How to Reach Us:****Home Page:**

[www.freescale.com](http://www.freescale.com)

**Web Support:**

<http://www.freescale.com/support>

**USA/Europe or Locations Not Listed:**

Freescale Semiconductor, Inc.  
Technical Information Center, EL516  
2100 East Elliot Road  
Tempe, Arizona 85284  
+1-800-521-6274 or +1-480-768-2130  
[www.freescale.com/support](http://www.freescale.com/support)

**Europe, Middle East, and Africa:**

Freescale Halbleiter Deutschland GmbH  
Technical Information Center  
Schatzbogen 7  
81829 Muenchen, Germany  
+44 1296 380 456 (English)  
+46 8 52200080 (English)  
+49 89 92103 559 (German)  
+33 1 69 35 48 48 (French)  
[www.freescale.com/support](http://www.freescale.com/support)

**Japan:**

Freescale Semiconductor Japan Ltd.  
Headquarters  
ARCO Tower 15F  
1-8-1, Shimo-Meguro, Meguro-ku,  
Tokyo 153-0064  
Japan  
0120 191014 or +81 3 5437 9125  
[support.japan@freescale.com](mailto:support.japan@freescale.com)

**Asia/Pacific:**

Freescale Semiconductor China Ltd.  
Exchange Building 23F  
No. 118 Jianguo Road  
Chaoyang District  
Beijing 100022  
China  
+86 10 5879 8000  
[support.asia@freescale.com](mailto:support.asia@freescale.com)

**For Literature Requests Only:**

Freescale Semiconductor Literature Distribution Center  
P.O. Box 5405  
Denver, Colorado 80217  
1-800-441-2447 or 303-675-2140  
Fax: 303-675-2150  
[LDCForFreescaleSemiconductor@hibbertgroup.com](mailto:LDCForFreescaleSemiconductor@hibbertgroup.com)

Document Number: AN3863  
Rev. 4  
07/2011

Information in this document is provided solely to enable system and software implementers to use Freescale Semiconductor products. There are no express or implied copyright licenses granted hereunder to design or fabricate any integrated circuits or integrated circuits based on the information in this document.

Freescale Semiconductor reserves the right to make changes without further notice to any products herein. Freescale Semiconductor makes no warranty, representation or guarantee regarding the suitability of its products for any particular purpose, nor does Freescale Semiconductor assume any liability arising out of the application or use of any product or circuit, and specifically disclaims any and all liability, including without limitation consequential or incidental damages. "Typical" parameters that may be provided in Freescale Semiconductor data sheets and/or specifications can and do vary in different applications and actual performance may vary over time. All operating parameters, including "Typicals", must be validated for each customer application by customer's technical experts. Freescale Semiconductor does not convey any license under its patent rights nor the rights of others. Freescale Semiconductor products are not designed, intended, or authorized for use as components in systems intended for surgical implant into the body, or other applications intended to support or sustain life, or for any other application in which the failure of the Freescale Semiconductor product could create a situation where personal injury or death may occur. Should Buyer purchase or use Freescale Semiconductor products for any such unintended or unauthorized application, Buyer shall indemnify and hold Freescale Semiconductor and its officers, employees, subsidiaries, affiliates, and distributors harmless against all claims, costs, damages, and expenses, and reasonable attorney fees arising out of, directly or indirectly, any claim of personal injury or death associated with such unintended or unauthorized use, even if such claim alleges that Freescale Semiconductor was negligent regarding the design or manufacture of the part.

RoHS-compliant and/or Pb-free versions of Freescale products have the functionality and electrical characteristics as their non-RoHS-compliant and/or non-Pb-free counterparts. For further information, see <http://www.freescale.com> or contact your Freescale sales representative.

For information on Freescale's Environmental Products program, go to <http://www.freescale.com/epp>.

Freescale™ and the Freescale logo are trademarks of Freescale Semiconductor, Inc. All other product or service names are the property of their respective owners.  
© Freescale Semiconductor, Inc. 2010. All rights reserved.