GMCLIB User's Guide

DSP56800EX

Document Number: DSP56800EXGMCLIBUG
Rev. 4, 04/2019





Contents

Section number	Title	Page
Chapter 1		
Library		
1.1	Introduction.....	5
1.2	Library integration into project (CodeWarrior™ Development Studio)	7
Chapter 2		
Algorithms in detail		
2.1	GMCLIB_Clark.....	17
2.2	GMCLIB_ClarkInv.....	18
2.3	GMCLIB_Park.....	20
2.4	GMCLIB_ParkInv.....	21
2.5	GMCLIB_DecouplingPMSM.....	23
2.6	GMCLIB_ElimDcBusRipFOC.....	27
2.7	GMCLIB_ElimDcBusRip.....	32
2.8	GMCLIB_SvmStd.....	36
2.9	GMCLIB_SvmIct.....	51
2.10	GMCLIB_SvmU0n.....	55
2.11	GMCLIB_SvmU7n.....	59
2.12	GMCLIB_SvmDpwm.....	63
2.13	GMCLIB_SvmExDpwm.....	66



Chapter 1

Library

1.1 Introduction

1.1.1 Overview

This user's guide describes the General Motor Control Library (GMCLIB) for the family of DSP56800EX core-based digital signal controllers. This library contains optimized functions.

1.1.2 Data types

GMCLIB supports several data types: (un)signed integer, fractional, and accumulator. The integer data types are useful for general-purpose computation; they are familiar to the MPU and MCU programmers. The fractional data types enable powerful numeric and digital-signal-processing algorithms to be implemented. The accumulator data type is a combination of both; that means it has the integer and fractional portions.

The following list shows the integer types defined in the libraries:

- [Unsigned 16-bit integer](#) — $\langle 0 ; 65535 \rangle$ with the minimum resolution of 1
- [Signed 16-bit integer](#) — $\langle -32768 ; 32767 \rangle$ with the minimum resolution of 1
- [Unsigned 32-bit integer](#) — $\langle 0 ; 4294967295 \rangle$ with the minimum resolution of 1
- [Signed 32-bit integer](#) — $\langle -2147483648 ; 2147483647 \rangle$ with the minimum resolution of 1

The following list shows the fractional types defined in the libraries:

- [Fixed-point 16-bit fractional](#) — $\langle -1 ; 1 - 2^{-15} \rangle$ with the minimum resolution of 2^{-15}
- [Fixed-point 32-bit fractional](#) — $\langle -1 ; 1 - 2^{-31} \rangle$ with the minimum resolution of 2^{-31}

The following list shows the accumulator types defined in the libraries:

- **Fixed-point 16-bit accumulator** — $\langle -256.0 ; 256.0 - 2^{-7} \rangle$ with the minimum resolution of 2^{-7}
- **Fixed-point 32-bit accumulator** — $\langle -65536.0 ; 65536.0 - 2^{-15} \rangle$ with the minimum resolution of 2^{-15}

1.1.3 API definition

GMCLIB uses the types mentioned in the previous section. To enable simple usage of the algorithms, their names use set prefixes and postfixes to distinguish the functions' versions. See the following example:

```
f32Result = MLIB_Mac_F32lss(f32Accum, f16Mult1, f16Mult2);
```

where the function is compiled from four parts:

- **MLIB**—this is the library prefix
- **Mac**—the function name—Multiply-Accumulate
- **F32**—the function output type
- **lss**—the types of the function inputs; if all the inputs have the same type as the output, the inputs are not marked

The input and output types are described in the following table:

Table 1-1. Input/output types

Type	Output	Input
frac16_t	F16	s
frac32_t	F32	l
acc32_t	A32	a

1.1.4 Supported compilers

GMCLIB for the DSP56800EX core is written in assembly language with C-callable interface. The library is built and tested using the following compilers:

- CodeWarrior™ Development Studio

For the CodeWarrior™ Development Studio, the library is delivered in the *gmclib.lib* file.

The interfaces to the algorithms included in this library are combined into a single public interface include file, *gmplib.h*. This is done to lower the number of files required to be included in your application.

1.1.5 Library configuration

1.1.6 Special issues

1. The equations describing the algorithms are symbolic. If there is positive 1, the number is the closest number to 1 that the resolution of the used fractional type allows. If there are maximum or minimum values mentioned, check the range allowed by the type of the particular function version.
2. The library functions require the core saturation mode to be turned off, otherwise the results can be incorrect. Several specific library functions are immune to the setting of the saturation mode.
3. The library functions round the result (the API contains Rnd) to the nearest (two's complement rounding) or to the nearest even number (convergent round). The mode used depends on the core option mode register (OMR) setting. See the core manual for details.
4. All non-inline functions are implemented without storing any of the volatile registers (refer to the compiler manual) used by the respective routine. Only the non-volatile registers (C10, D10, R5) are saved by pushing the registers on the stack. Therefore, if the particular registers initialized before the library function call are to be used after the function call, it is necessary to save them manually.

1.2 Library integration into project (CodeWarrior™ Development Studio)

This section provides a step-by-step guide to quickly and easily integrate the GMCLIB into an empty project using CodeWarrior™ Development Studio. This example uses the MC56F84789 part, and the default installation path (C:\NXPARTCESL\VDSP56800EX_RTCESL_4.5) is supposed. If you have a different installation path, you must use that path instead.

1.2.1 New project

To start working on an application, create a new project. If the project already exists and is open, skip to the next section. Follow the steps given below to create a new project.

1. Launch CodeWarrior™ Development Studio.
2. Choose File > New > Bareboard Project, so that the "New Bareboard Project" dialog appears.
3. Type a name of the project, for example, MyProject01.
4. If you don't use the default location, untick the "Use default location" checkbox, and type the path where you want to create the project folder; for example, C:\CWProjects\MyProject01, and click Next. See [Figure 1-1](#).

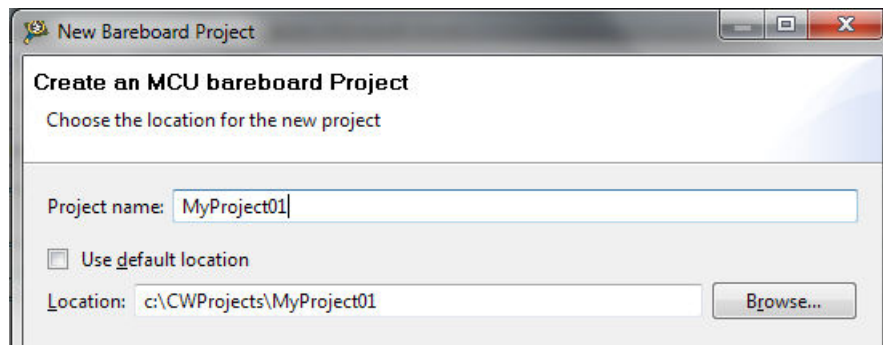

Figure 1-1. Project name and location

5. Expand the tree by clicking the 56800/E (DSC) and MC56F84789. Select the Application option and click Next. See [Figure 1-2](#).

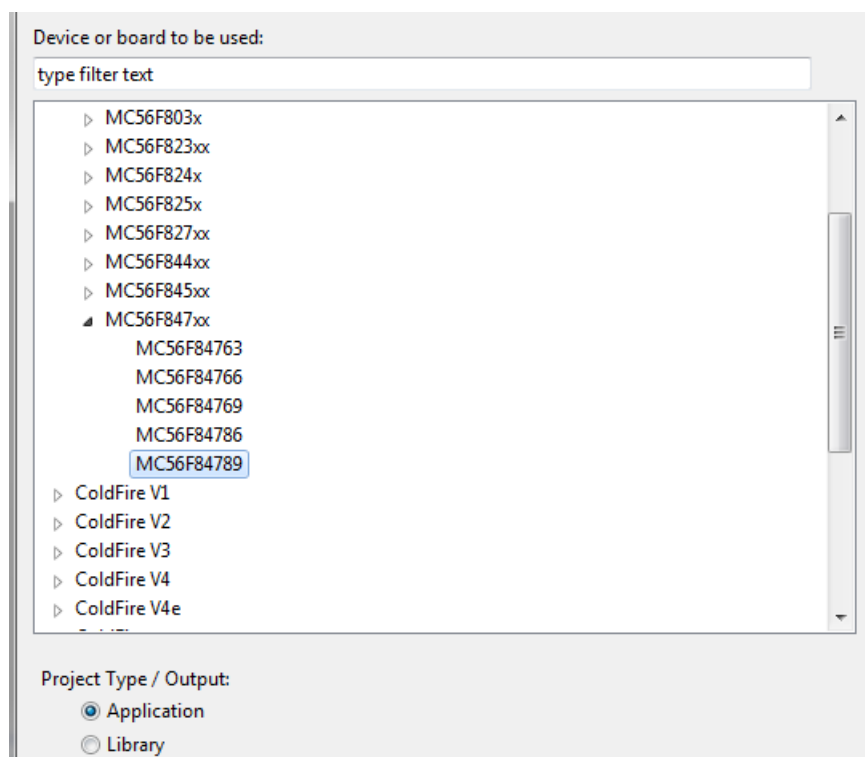

Figure 1-2. Processor selection

6. Now select the connection that will be used to download and debug the application. In this case, select the option P&E USB MultiLink Universal[FX] / USB MultiLink and Freescale USB TAP, and click Next. See [Figure 1-3](#).

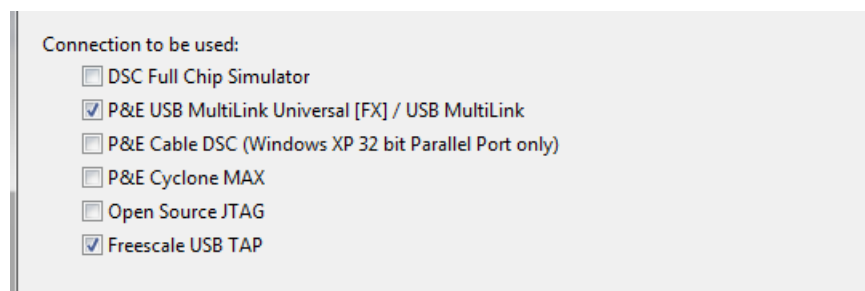

Figure 1-3. Connection selection

7. From the options given, select the Simple Mixed Assembly and C language, and click Finish. See [Figure 1-4](#).

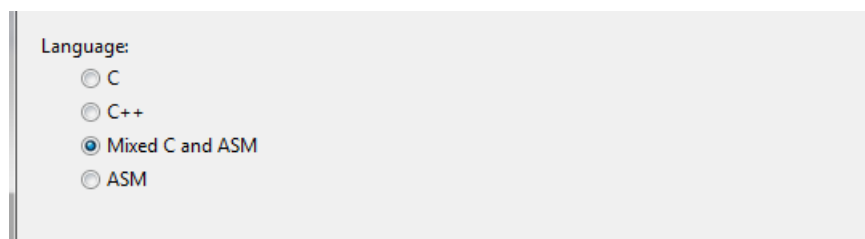

Figure 1-4. Language choice

The new project is now visible in the left-hand part of CodeWarrior™ Development Studio. See [Figure 1-5](#).

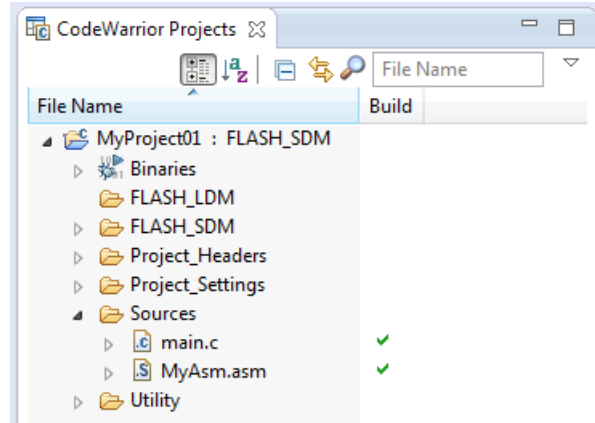

Figure 1-5. Project folder

1.2.2 Library path variable

To make the library integration easier, create a variable that will hold the information about the library path.

1. Right-click the MyProject01 node in the left-hand part and click Properties, or select Project > Properties from the menu. The project properties dialog appears.
2. Expand the Resource node and click Linked Resources. See [Figure 1-6](#).

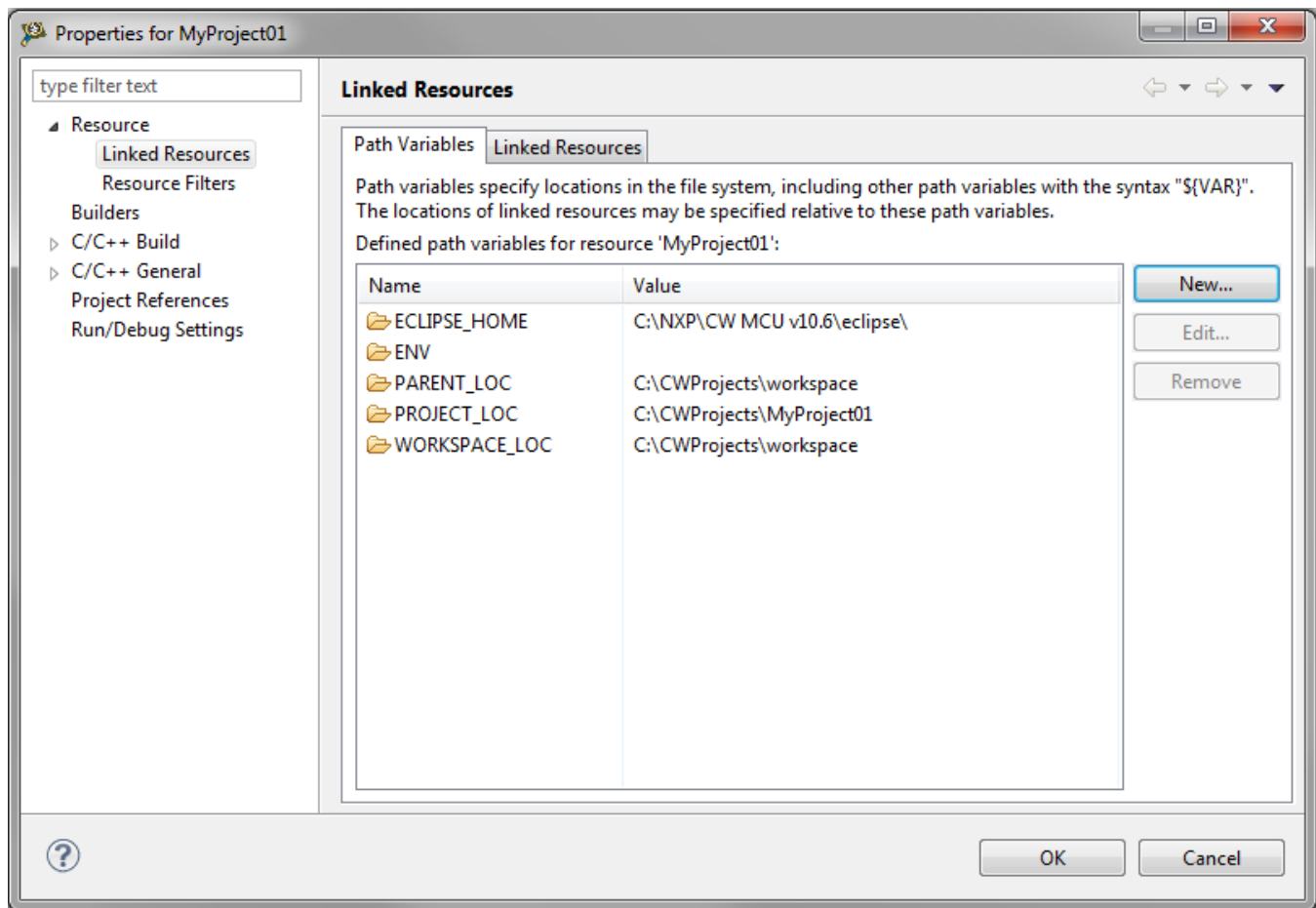

Figure 1-6. Project properties

3. Click the 'New...' button on the right-hand side.
4. In the dialog that appears (see [Figure 1-7](#)), type this variable name into the Name box: RTCESL_LOC
5. Select the library parent folder by clicking 'Folder...' or just typing the following path into the Location box: C:\NXP\RTCESL\DSP56800EX_RTCESL_4.5_CW and click OK.
6. Click OK in the previous dialog.

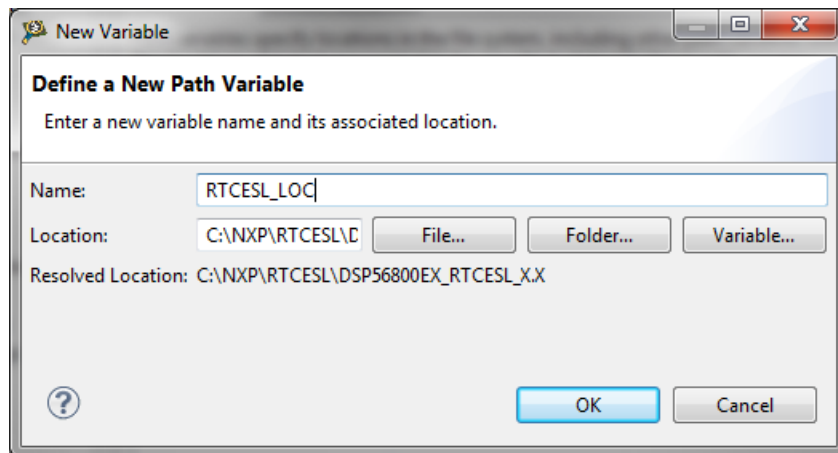

Figure 1-7. New variable

1.2.3 Library folder addition

To use the library, add it into the CodeWarrior Project tree dialog.

1. Right-click the MyProject01 node in the left-hand part and click New > Folder, or select File > New > Folder from the menu. A dialog appears.
2. Click Advanced to show the advanced options.
3. To link the library source, select the third option—Link to alternate location (Linked Folder).
4. Click Variables..., and select the RTCESL_LOC variable in the dialog that appears, click OK, and/or type the variable name into the box. See [Figure 1-8](#).
5. Click Finish, and you will see the library folder linked in the project. See [Figure 1-9](#)

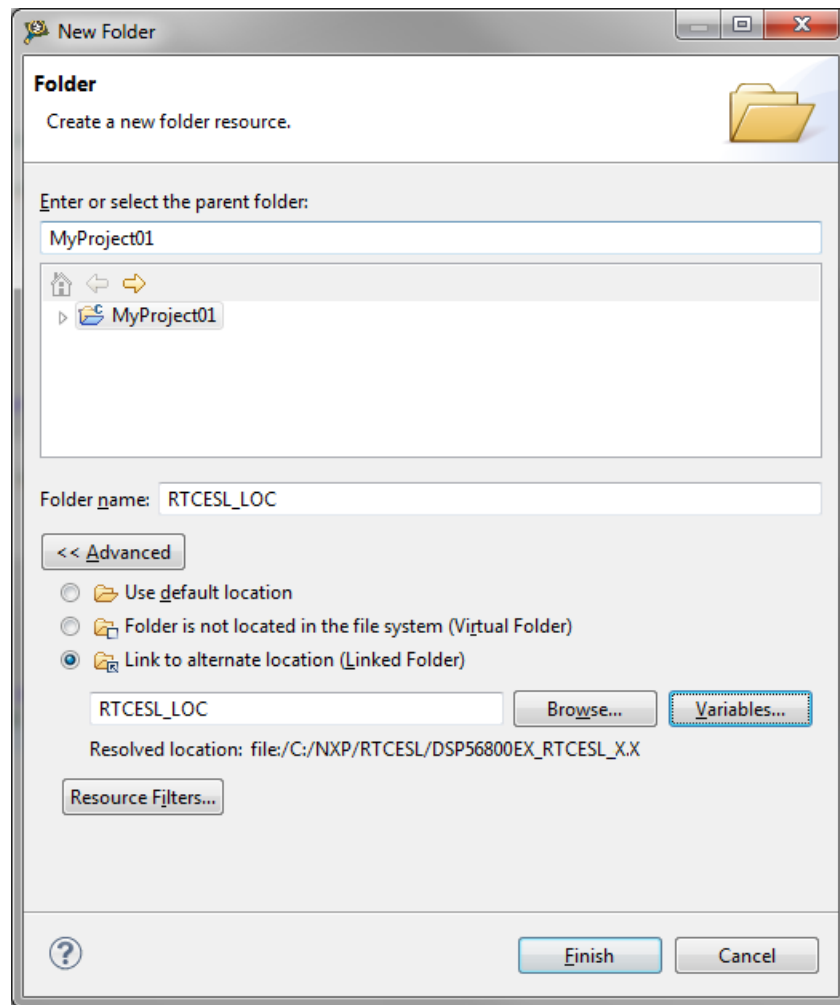

Figure 1-8. Folder link

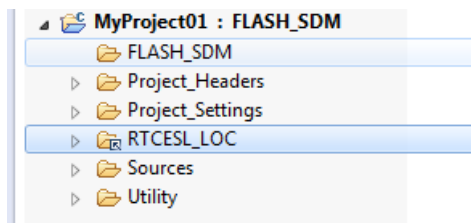

Figure 1-9. Projects libraries paths

1.2.4 Library path setup

GMCLIB requires MLIB and GFLIB to be included too. Therefore, the following steps show the inclusion of all dependent modules.

1. Right-click the MyProject01 node in the left-hand part and click Properties, or select Project > Properties from the menu. A dialog with the project properties appears.
2. Expand the C/C++ Build node, and click Settings.

3. In the right-hand tree, expand the DSC Linker node, and click Input. See [Figure 1-11](#).
4. In the third dialog Additional Libraries, click the 'Add...' icon, and a dialog appears.
5. Look for the RTCESL_LOC variable by clicking Variables..., and then finish the path in the box by adding one of the following:
 - `${RTCESL_LOC}\MLIB\mllib_SDM.lib`—for small data model projects
 - `${RTCESL_LOC}\MLIB\mllib_LDM.lib`—for large data model projects
6. Tick the box Relative To, and select RTCESL_LOC next to the box. See [Figure 1-9](#). Click OK.
7. Click the 'Add...' icon in the third dialog Additional Libraries.
8. Look for the RTCESL_LOC variable by clicking Variables..., and then finish the path in the box by adding one of the following:
 - `${RTCESL_LOC}\GFLIB\gflib_SDM.lib`—for small data model projects
 - `${RTCESL_LOC}\GFLIB\gflib_LDM.lib`—for large data model projects
9. Tick the box Relative To, and select RTCESL_LOC next to the box. Click OK.
10. Click the 'Add...' icon in the Additional Libraries dialog.
11. Look for the RTCESL_LOC variable by clicking Variables..., and then finish the path in the box by adding one of the following:
 - `${RTCESL_LOC}\GMCLIB\gmclib_SDM.lib`—for small data model projects
 - `${RTCESL_LOC}\GMCLIB\gmclib_LDM.lib`—for large data model projects
12. Tick the box Relative To, and select RTCESL_LOC next to the box. Click OK.
13. Now, you will see the libraries added in the box. See [Figure 1-11](#).

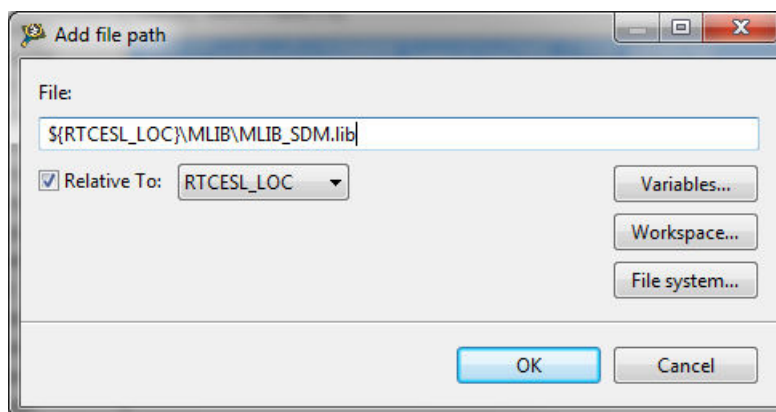

Figure 1-10. Library file inclusion

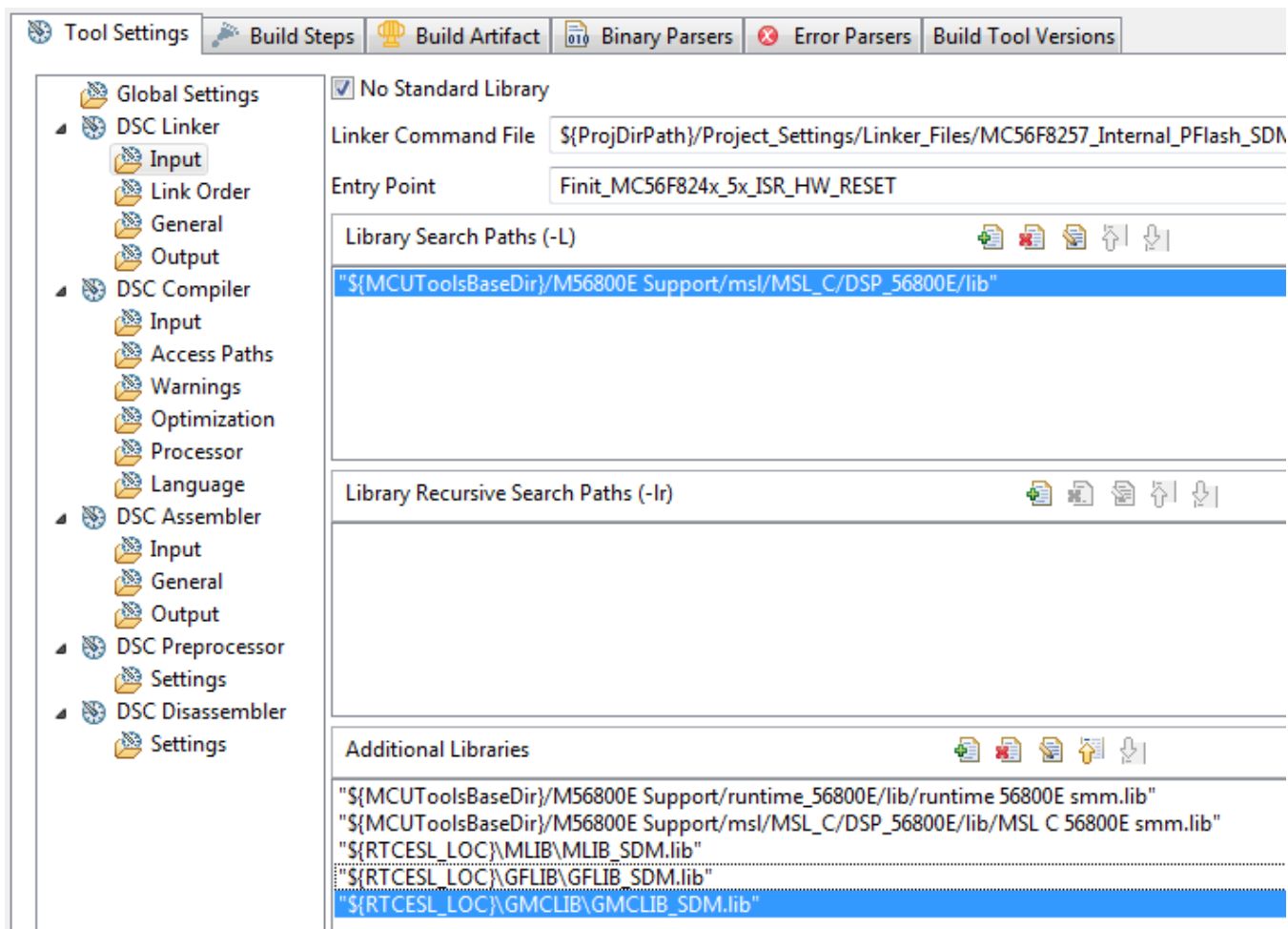

Figure 1-11. Linker setting

14. In the tree under the DSC Compiler node, click Access Paths.
15. In the Search User Paths dialog (#include "..."), click the 'Add...' icon, and a dialog will appear.
16. Look for the RTCESL_LOC variable by clicking Variables..., and then finish the path in the box to be: `{RTCESL_LOC}\MLIB\include`.
17. Tick the box Relative To, and select RTCESL_LOC next to the box. See [Figure 1-12](#). Click OK.
18. Click the 'Add...' icon in the Search User Paths dialog (#include "...").
19. Look for the RTCESL_LOC variable by clicking Variables..., and then finish the path in the box to be: `{RTCESL_LOC}\GFLIB\include`.
20. Tick the box Relative To, and select RTCESL_LOC next to the box. Click OK.
21. Click the 'Add...' icon in the Search User Paths dialog (#include "...").
22. Look for the RTCESL_LOC variable by clicking Variables..., and then finish the path in the box to be: `{RTCESL_LOC}\GMCLIB\include`.
23. Tick the box Relative To, and select RTCESL_LOC next to the box. Click OK.
24. Now you will see the paths added in the box. See [Figure 1-13](#). Click OK.

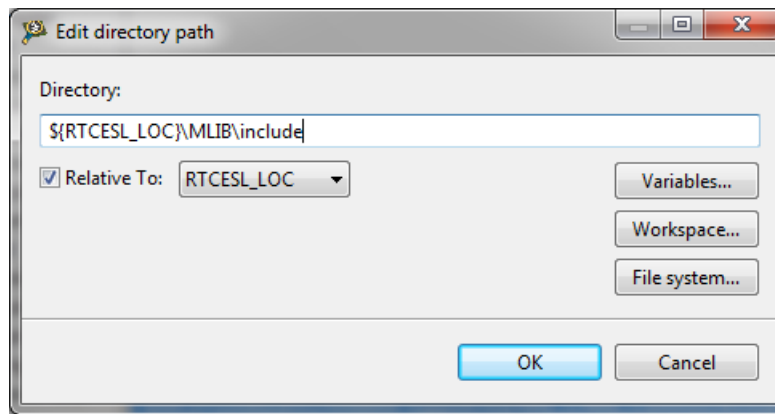

Figure 1-12. Library include path addition

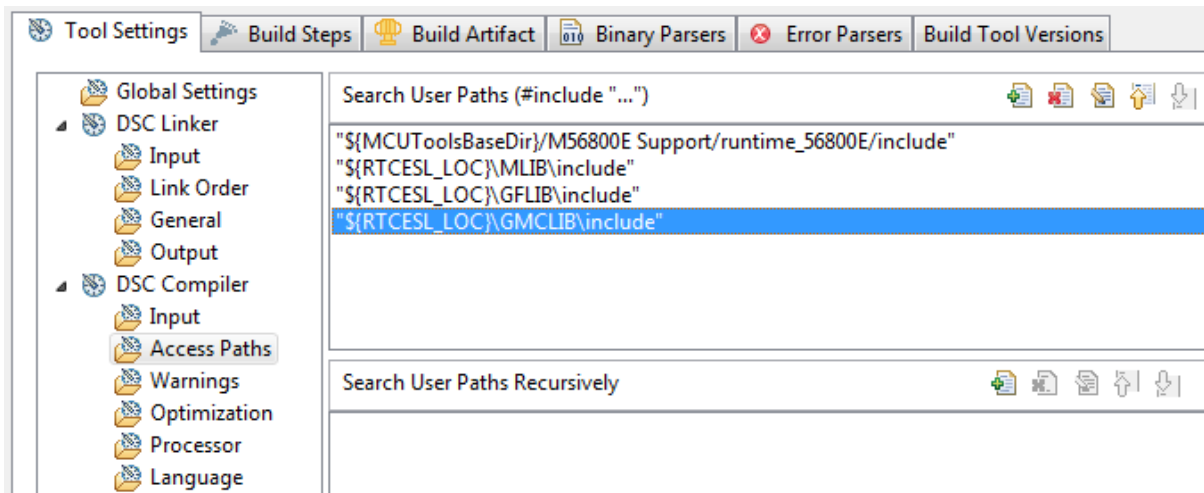

Figure 1-13. Compiler setting

The final step is typing the `#include` syntax into the code. Include the library into the `main.c` file. In the left-hand dialog, open the Sources folder of the project, and double-click the `main.c` file. After the `main.c` file opens up, include the following lines into the `#include` section:

```
#include "mlib.h"
#include "gflib.h"
#include "gmclib.h"
```

When you click the Build icon (hammer), the project will be compiled without errors.

Chapter 2

Algorithms in detail

2.1 GMCLIB_Clark

The [GMCLIB_Clark](#) function calculates the Clarke transformation, which is used to transform values (flux, voltage, current) from the three-phase coordinate system to the two-phase (α - β) orthogonal coordinate system, according to the following equations:

$$\alpha = a$$

Equation 1

$$\beta = \frac{1}{\sqrt{3}}b - \frac{1}{\sqrt{3}}c$$

Equation 2

2.1.1 Available versions

This function is available in the following versions:

- Fractional output - the output is the fractional portion of the result; the result is within the range $<-1 ; 1$). The result may saturate.

The available versions of the [GMCLIB_Clark](#) function are shown in the following table:

Table 2-1. Function versions

Function name	Input type	Output type	Result type
GMCLIB_Clark_F16	GMCLIB_3COOR_T_F16 *	GMCLIB_2COOR_ALBE_T_F16 *	void
	Clarke transformation of a 16-bit fractional three-phase system input to a 16-bit fractional two-phase system. The input and output are within the fractional range $<-1 ; 1$).		

2.1.2 Declaration

The available [GMCLIB_Clark](#) functions have the following declarations:

```
void GMCLIB_Clark_F16(const GMCLIB_3COOR_T_F16 *psIn, GMCLIB_2COOR_ALBE_T_F16 *psOut)
```

2.1.3 Function use

The use of the [GMCLIB_Clark](#) function is shown in the following examples:

Fixed-point version:

```
#include "gmclib.h"

static GMCLIB_2COOR_ALBE_T_F16 sAlphaBeta;
static GMCLIB_3COOR_T_F16 sAbc;

void Isr(void);

void main(void)
{
    /* ABC structure initialization */
    sAbc.f16A = FRAC16(0.0);
    sAbc.f16B = FRAC16(0.0);
    sAbc.f16C = FRAC16(0.0);
}

/* Periodical function or interrupt */
void Isr(void)
{
    /* Clarke Transformation calculation */
    GMCLIB_Clark_F16(&sAbc, &sAlphaBeta);
}
```

2.2 GMCLIB_ClarkInv

The [GMCLIB_ClarkInv](#) function calculates the Clarke transformation, which is used to transform values (flux, voltage, current) from the two-phase (α - β) orthogonal coordinate system to the three-phase coordinate system, according to the following equations:

$$a = \alpha$$

Equation 3

$$b = -\frac{1}{2}\alpha + \frac{\sqrt{3}}{2}\beta$$

Equation 4

$$c = -(a+b)$$

Equation 5

2.2.1 Available versions

This function is available in the following versions:

- Fractional output - the output is the fractional portion of the result; the result is within the range <-1 ; 1). The result may saturate.

The available versions of the [GMCLIB_ClarkInv](#) function are shown in the following table:

Table 2-2. Function versions

Function name	Input type	Output type	Result type
GMCLIB_ClarkInv_F16	GMCLIB_2COOR_ALBE_T_F16 *	GMCLIB_3COOR_T_F16 *	void
	Inverse Clarke transformation with a 16-bit fractional two-phase system input and a 16-bit fractional three-phase output. The input and output are within the fractional range <-1 ; 1).		

2.2.2 Declaration

The available [GMCLIB_ClarkInv](#) functions have the following declarations:

```
void GMCLIB_ClarkInv_F16(const GMCLIB\_2COOR\_ALBE\_T\_F16 *psIn, GMCLIB\_3COOR\_T\_F16 *psOut)
```

2.2.3 Function use

The use of the [GMCLIB_ClarkInv](#) function is shown in the following examples:

Fixed-point version:

```
#include "gmclib.h"

static GMCLIB\_2COOR\_ALBE\_T\_F16 sAlphaBeta;
static GMCLIB\_3COOR\_T\_F16 sAbc;

void Isr(void);

void main(void)
{
    /* Alpha, Beta structure initialization */
    sAlphaBeta.f16Alpha = FRAC16(0.0);
    sAlphaBeta.f16Beta = FRAC16(0.0);
}
```

```

/* Periodical function or interrupt */
void Isr(void)
{
    /* Inverse Clarke Transformation calculation */
    GMCLIB_ClarkInv_F16(&sAlphaBeta, &sAbc);
}

```

2.3 GMCLIB_Park

The [GMCLIB_Park](#) function calculates the Park transformation, which transforms values (flux, voltage, current) from the stationary two-phase (α - β) orthogonal coordinate system to the rotating two-phase (d-q) orthogonal coordinate system, according to the following equations:

$$d = \alpha \cdot \cos(\theta) + \beta \cdot \sin(\theta)$$

Equation 6

$$q = \beta \cdot \cos(\theta) - \alpha \cdot \sin(\theta)$$

Equation 7

where:

- θ is the position (angle)

2.3.1 Available versions

This function is available in the following versions:

- Fractional output - the output is the fractional portion of the result; the result is within the range $<-1 ; 1$). The result may saturate.

The available versions of the [GMCLIB_Park](#) function are shown in the following table:

Table 2-3. Function versions

Function name	Input type	Output type	Result type
GMCLIB_Park_F16	GMCLIB_2COOR_ALBE_T_F16 *	GMCLIB_2COOR_DQ_T_F16 *	void
	GMCLIB_2COOR_SINCOS_T_F16 *		
The Park transformation of a 16-bit fractional two-phase stationary system input to a 16-bit fractional two-phase rotating system, using a 16-bit fractional angle two-component (sin / cos) position information. The inputs and the output are within the fractional range $<-1 ; 1$).			

2.3.2 Declaration

The available `GMCLIB_Park` functions have the following declarations:

```
void GMCLIB_Park_F16(const GMCLIB_2COOR_ALBE_T_F16 *psIn, const GMCLIB_2COOR_SINCOS_T_F16
*psAnglePos, GMCLIB_2COOR_DQ_T_F16 *psOut)
```

2.3.3 Function use

The use of the `GMCLIB_Park` function is shown in the following examples:

Fixed-point version:

```
#include "gmclib.h"

static GMCLIB_2COOR_ALBE_T_F16 sAlphaBeta;
static GMCLIB_2COOR_DQ_T_F16 sDQ;
static GMCLIB_2COOR_SINCOS_T_F16 sAngle;

void Isr(void);

void main(void)
{
    /* Alpha, Beta structure initialization */
    sAlphaBeta.f16Alpha = FRAC16(0.0);
    sAlphaBeta.f16Beta = FRAC16(0.0);

    /* Angle structure initialization */
    sAngle.f16Sin = FRAC16(0.0);
    sAngle.f16Cos = FRAC16(1.0);
}

/* Periodical function or interrupt */
void Isr(void)
{
    /* Park Transformation calculation */
    GMCLIB_Park_F16(&sAlphaBeta, &sAngle, &sDQ);
}
```

2.4 GMCLIB_ParkInv

The `GMCLIB_ParkInv` function calculates the Park transformation, which transforms values (flux, voltage, current) from the rotating two-phase (d-q) orthogonal coordinate system to the stationary two-phase (α - β) coordinate system, according to the following equations:

$$\alpha = d \cdot \cos(\theta) - q \cdot \sin(\theta)$$

Equation 8

$$\beta = d \cdot \sin(\theta) + q \cdot \cos(\theta)$$

Equation 9

where:

- θ is the position (angle)

2.4.1 Available versions

This function is available in the following versions:

- Fractional output - the output is the fractional portion of the result; the result is within the range $<-1 ; 1$). The result may saturate.

The available versions of the [GMCLIB_ParkInv](#) function are shown in the following table:

Table 2-4. Function versions

Function name	Input type	Output type	Result type
GMCLIB_ParkInv_F16	GMCLIB_2COOR_DQ_T_F16 *	GMCLIB_2COOR_ALBE_T_F16 *	void
	GMCLIB_2COOR_SINCOS_T_F16 *		
Inverse Park transformation of a 16-bit fractional two-phase rotating system input to a 16-bit fractional two-phase stationary system, using a 16-bit fractional angle two-component (sin / cos) position information. The inputs and the output are within the fractional range $<-1 ; 1$).			

2.4.2 Declaration

The available [GMCLIB_ParkInv](#) functions have the following declarations:

```
void GMCLIB_ParkInv_F16(const GMCLIB_2COOR_DQ_T_F16 *psIn, const GMCLIB_2COOR_SINCOS_T_F16
*psAnglePos, GMCLIB_2COOR_ALBE_T_F16 *psOut)
```

2.4.3 Function use

The use of the [GMCLIB_ParkInv](#) function is shown in the following examples:

Fixed-point version:

```
#include "gmclib.h"

static GMCLIB_2COOR_ALBE_T_F16 sAlphaBeta;
static GMCLIB_2COOR_DQ_T_F16 sDQ;
static GMCLIB_2COOR_SINCOS_T_F16 sAngle;

void Isr(void);

void main(void)
{
    /* D, Q structure initialization */
    sDQ.f16D = FRAC16(0.0);
    sDQ.f16Q = FRAC16(0.0);

    /* Angle structure initialization */
    sAngle.f16Sin = FRAC16(0.0);
    sAngle.f16Cos = FRAC16(1.0);
}

/* Periodical function or interrupt */
void Isr(void)
{
    /* Inverse Park Transformation calculation */
    GMCLIB_ParkInv_F16(&sDQ, &sAngle, &sAlphaBeta);
}
```

2.5 GMCLIB_DecouplingPMSM

The `GMCLIB_DecouplingPMSM` function calculates the cross-coupling voltages to eliminate the d-q axis coupling that causes nonlinearity of the control.

The d-q model of the motor contains cross-coupling voltage that causes nonlinearity of the control. [Figure 2-1](#) represents the d-q model of the motor that can be described using the following equations, where the underlined portion is the cross-coupling voltage:

$$\begin{aligned}
 u_d &= R_s \cdot i_d + L_d \frac{d}{dt} i_d + \underline{L_q \cdot \omega_{el} \cdot i_q} \\
 u_q &= R_s \cdot i_q + L_q \frac{d}{dt} i_q - \underline{L_d \cdot \omega_{el} \cdot i_d} + \omega_{el} \cdot \psi_r
 \end{aligned}$$

Equation 10

where:

- u_d, u_q are the d and q voltages
- i_d, i_q are the d and q currents
- R_s is the stator winding resistance
- L_d, L_q are the stator winding d and q inductances
- ω_{el} is the electrical angular speed
- ψ_r is the rotor flux constant

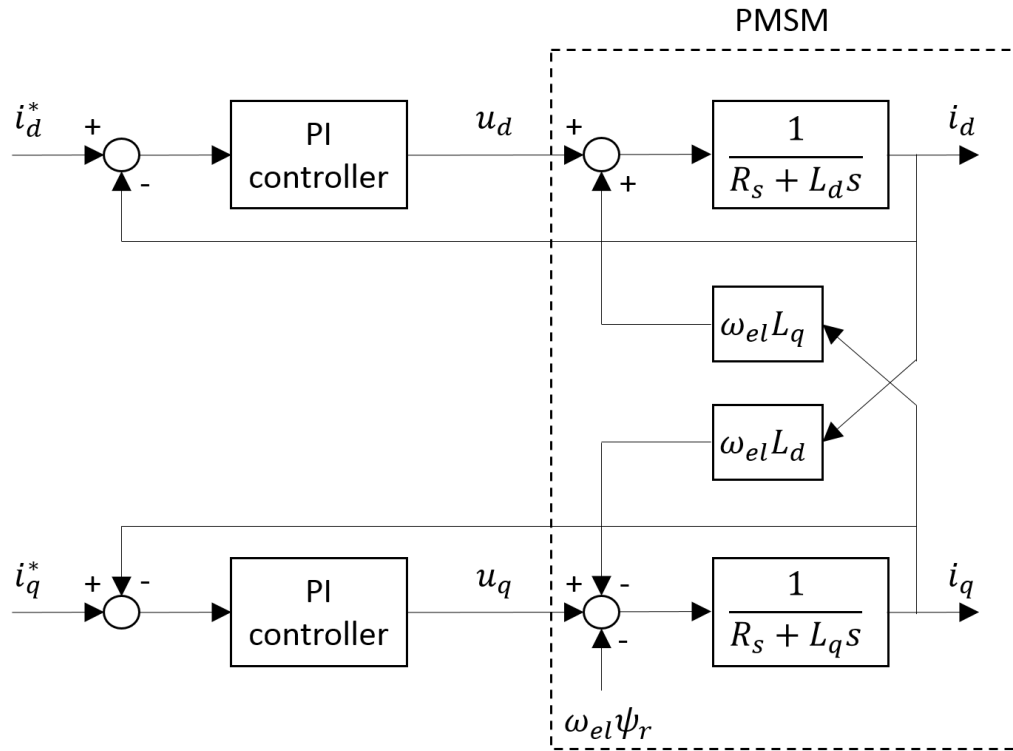

Figure 2-1. The d-q PMSM model

To eliminate the nonlinearity, the cross-coupling voltage is calculated using the [GMCLIB_DecouplingPMSM](#) algorithm, and feedforwarded to the d and q voltages. The decoupling algorithm is calculated using the following equations:

$$\begin{aligned}
 u_{ddec} &= u_d - L_q \cdot \omega_{el} \cdot i_q \\
 u_{qdec} &= u_q + L_d \cdot \omega_{el} \cdot i_d
 \end{aligned}$$

Equation 11

where:

- u_d, u_q are the d and q voltages; inputs to the algorithm
- u_{ddec}, u_{qdec} are the d and q decoupled voltages; outputs from the algorithm

The fractional representation of the d-component equation is as follows:

$$\begin{aligned}
 u_{ddec} &= u_d - \omega_{el} \cdot i_q \left(L_q \cdot \omega_{el_max} \cdot \frac{i_{max}}{u_{max}} \right) \\
 k_q &= L_q \cdot \omega_{el_max} \cdot \frac{i_{max}}{u_{max}} \\
 u_{ddec} &= u_d - \omega_{el} \cdot i_q \cdot k_q
 \end{aligned}$$

Equation 12

The fractional representation of the q-component equation is as follows:

$$u_{qdec} = u_q + \omega_{el} \cdot i_d \left(L_d \cdot \omega_{el_max} \cdot \frac{i_{max}}{u_{max}} \right)$$

$$k_d = L_d \cdot \omega_{el_max} \cdot \frac{i_{max}}{u_{max}}$$

$$u_{qdec} = u_q + \omega_{el} \cdot i_d \cdot k_d$$

Equation 13

where:

- k_d, k_q are the scaling coefficients
- i_{max} is the maximum current
- u_{max} is the maximum voltage
- ω_{el_max} is the maximum electrical speed

The k_d and k_q parameters must be set up properly.

The principle of the algorithm is depicted in [Figure 2-2](#) :

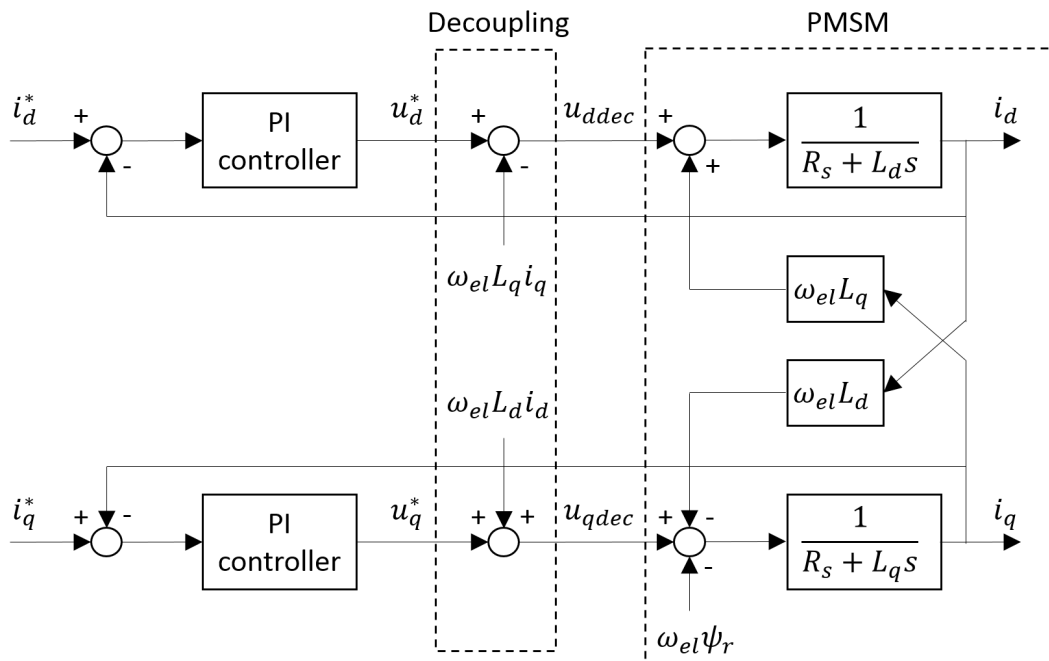

Figure 2-2. Algorithm diagram

2.5.1 Available versions

This function is available in the following versions:

- Fractional output - the output is the fractional portion of the result; the result is within the range $<-1 ; 1$). The result may saturate. The parameters use the accumulator types.

The available versions of the [GMCLIB_DecouplingPMSM](#) function are shown in the following table:

Table 2-5. Function versions

Function name	Input/output type		Result type
GMCLIB_DecouplingPMSM_F16	Input	GMCLIB_2COOR_DQ_T_F16 *	void
		GMCLIB_2COOR_DQ_T_F16 *	
		frac16_t	
	Parameters	GMCLIB_DECOUPLINGPMSM_T_A32 *	
	Output	GMCLIB_2COOR_DQ_T_F16 *	
The PMSM decoupling with a 16-bit fractional d-q voltage, current inputs, and a 16-bit fractional electrical speed input. The parameters are 32-bit accumulator types. The output is a 16-bit fractional decoupled d-q voltage. The inputs and the output are within the range <-1 ; 1).			

2.5.2 GMCLIB_DECOUPLINGPMSM_T_A32 type description

Variable name	Input type	Description
a32KdGain	acc32_t	Direct axis decoupling parameter. The parameter is within the range <0 ; 65536.0)
a32KqGain	acc32_t	Quadrature axis decoupling parameter. The parameter is within the range <0 ; 65536.0)

2.5.3 Declaration

The available [GMCLIB_DecouplingPMSM](#) functions have the following declarations:

```
void GMCLIB_DecouplingPMSM_F16(const GMCLIB\_2COOR\_DQ\_T\_F16 *psUDQ, const
GMCLIB\_2COOR\_DQ\_T\_F16 *psIDQ, frac16\_t f16SpeedEl, const GMCLIB\_DECOUPLINGPMSM\_T\_A32
*psParam, GMCLIB\_2COOR\_DQ\_T\_F16 *psUDQDec)
```

2.5.4 Function use

The use of the [GMCLIB_DecouplingPMSM](#) function is shown in the following examples:

Fixed-point version:

```

#include "gmclib.h"

static GMCLIB_2COOR_DQ_T_F16 sVoltageDQ;
static GMCLIB_2COOR_DQ_T_F16 sCurrentDQ;
static frac16_t f16AngularSpeed;
static GMCLIB_DECOUPLINGPMSM_T_A32 sDecouplingParam;
static GMCLIB_2COOR_DQ_T_F16 sVoltageDQDecoupled;

void Isr(void);

void main(void)
{
    /* Voltage D, Q structure initialization */
    sVoltageDQ.f16D = FRAC16(0.0);
    sVoltageDQ.f16Q = FRAC16(0.0);

    /* Current D, Q structure initialization */
    sCurrentDQ.f16D = FRAC16(0.0);
    sCurrentDQ.f16Q = FRAC16(0.0);

    /* Speed initialization */
    f16AngularSpeed = FRAC16(0.0);

    /* Motor parameters for decoupling Kd = 40, Kq = 20 */
    sDecouplingParam.a32KdGain = ACC32(40.0);
    sDecouplingParam.a32KqGain = ACC32(20.0);
}

/* Periodical function or interrupt */
void Isr(void)
{
    /* Decoupling calculation */
    GMCLIB_DecouplingPMSM_F16(&sVoltageDQ, &sCurrentDQ, f16AngularSpeed, &sDecouplingParam,
    &sVoltageDQDecoupled);
}

```

2.6 GMCLIB_ElimDcBusRipFOC

The [GMCLIB_ElimDcBusRipFOC](#) function is used for the correct PWM duty cycle output calculation, based on the measured DC-bus voltage. The side effect is the elimination of the the DC-bus voltage ripple in the output PWM duty cycle. This function is meant to be used with a space vector modulation, whose modulation index (with respect to the DC-bus voltage) is an inverse square root of 3.

The general equation to calculate the duty cycle for the above-mentioned space vector modulation is as follows:

$$U_{PWM} = \frac{u_{FOC}}{u_{dcbus}} \cdot \sqrt{3}$$

Equation 14

where:

- U_{PWM} is the duty cycle output
- u_{FOC} is the real FOC voltage
- u_{dcbus} is the real measured DC-bus voltage

Using the previous equations, the [GMCLIB_ElimDcBusRipFOC](#) function compensates an amplitude of the direct- α and the quadrature- β component of the stator-reference voltage vector, using the formula shown in the following equations:

$$U_{\alpha}^* = \begin{cases} 0, & U_{\alpha} = 0 \wedge U_{dcbus} = 0 \\ 1, & U_{\alpha} \geq 0 \wedge |U_{\alpha}| \geq \frac{U_{dcbus}}{\sqrt{3}} \\ -1, & U_{\alpha} < 0 \wedge |U_{\alpha}| \geq \frac{U_{dcbus}}{\sqrt{3}} \\ \frac{U_{\alpha}}{U_{dcbus}} \cdot \sqrt{3}, & \text{else} \end{cases}$$

Equation 15

$$U_{\beta}^* = \begin{cases} 0, & U_{\beta} = 0 \wedge U_{dcbus} = 0 \\ 1, & U_{\beta} \geq 0 \wedge |U_{\beta}| \geq \frac{U_{dcbus}}{\sqrt{3}} \\ -1, & U_{\beta} < 0 \wedge |U_{\beta}| \geq \frac{U_{dcbus}}{\sqrt{3}} \\ \frac{U_{\beta}}{U_{dcbus}} \cdot \sqrt{3}, & \text{else} \end{cases}$$

Equation 16

where:

- U_{α}^* is the direct- α duty cycle ratio
- U_{β}^* is the quadrature- β duty cycle ratio
- U_{α} is the direct- α voltage
- U_{β} is the quadrature- β voltage

If the fractional arithmetic is used, the FOC and DC-bus voltages have their scales, which take place in [Equation 14 on page 27](#); the equation is as follows:

$$U_{PWM} = \frac{U_{FOC} U_{FOC_max}}{U_{dcbus} U_{dcbus_max}} \cdot \sqrt{3}$$

Equation 17

where:

- U_{FOC} is the scaled FOC voltage
- U_{dcbus} is the scaled measured DC-bus voltage
- U_{FOC_max} is the FOC voltage scale
- U_{dcbus_max} is the DC-bus voltage scale

If this algorithm is used with the space vector modulation with the ratio of square root equal to 3, then the FOC voltage scale is expressed as follows :

$$U_{FOC_max} = \frac{U_{dcbus_max}}{\sqrt{3}}$$

Equation 18

The equation can be simplified as follows:

$$U_{PWM} = \frac{U_{FOC} \frac{U_{dcbus_max}}{\sqrt{3}}}{U_{dcbus} U_{dcbus_max}} \cdot \sqrt{3} = \frac{U_{FOC}}{U_{dcbus}}$$

Equation 19

The [GMCLIB_ElimDcBusRipFOC](#) function compensates an amplitude of the direct- α and the quadrature- β component of the stator-reference voltage vector in the fractional arithmetic, using the formula shown in the following equations:

$$U_{\alpha}^* = \begin{cases} 0, & U_{\alpha} = 0 \wedge U_{dcbus} = 0 \\ 1, & U_{\alpha} > 0 \wedge |U_{\alpha}| \geq U_{dcbus} \\ -1, & U_{\alpha} < 0 \wedge |U_{\alpha}| \geq U_{dcbus} \\ \frac{U_{\alpha}}{U_{dcbus}}, & \text{else} \end{cases}$$

Equation 20

$$U_{\beta}^* = \begin{cases} 0, & U_{\beta} = 0 \wedge U_{dcbus} = 0 \\ 1, & U_{\beta} > 0 \wedge |U_{\beta}| \geq U_{dcbus} \\ -1, & U_{\beta} < 0 \wedge |U_{\beta}| \geq U_{dcbus} \\ \frac{U_{\beta}}{U_{dcbus}}, & \text{else} \end{cases}$$

Equation 21

where:

- U_{α}^* is the direct- α duty cycle ratio
- U_{β}^* is the quadrature- β duty cycle ratio
- U_{α} is the direct- α voltage
- U_{β} is the quadrature- β voltage

The [GMCLIB_ElimDcBusRipFOC](#) function can be used in general motor-control applications, and it provides elimination of the voltage ripple on the DC-bus of the power stage. [Figure 2-3](#) shows the results of the DC-bus ripple elimination, while compensating the ripples of the rectified voltage using a three-phase uncontrolled rectifier.

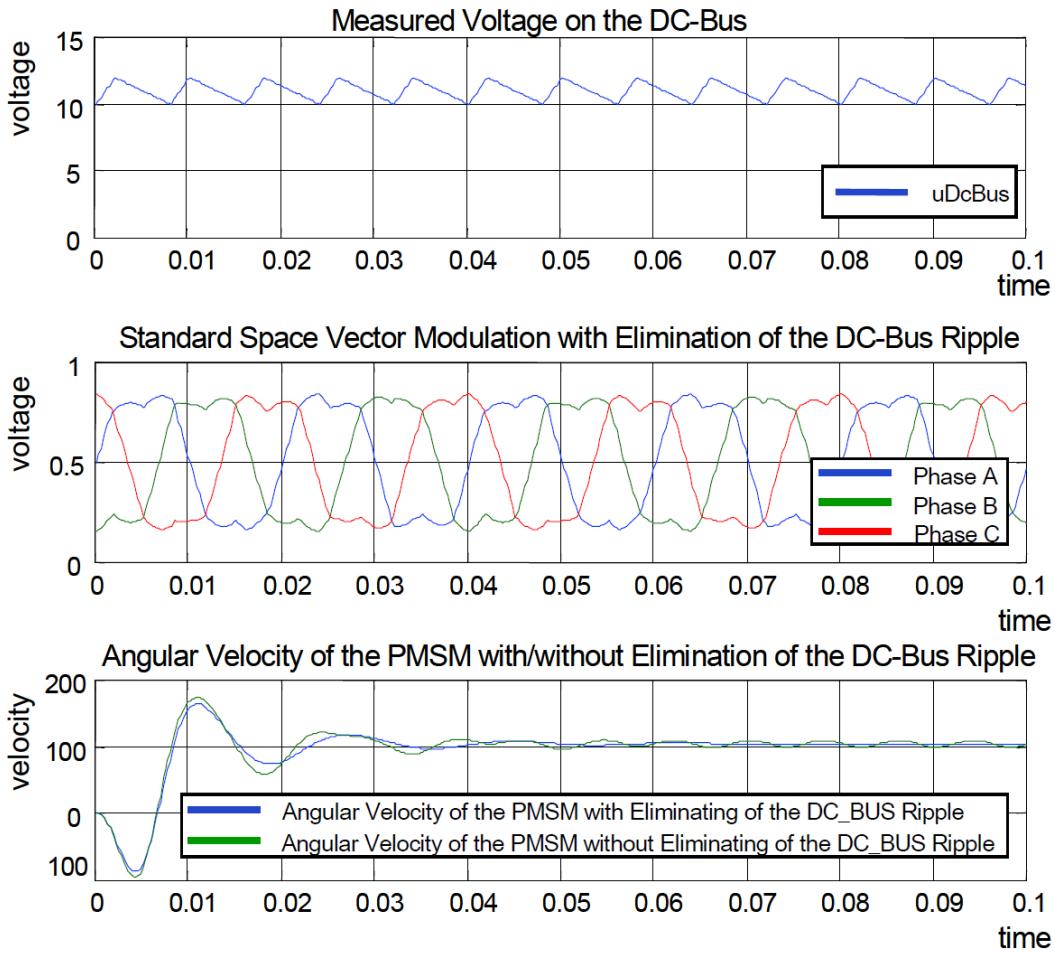

Figure 2-3. Results of the DC-bus voltage ripple elimination

2.6.1 Available versions

This function is available in the following versions:

- Fractional output - the output is the fractional portion of the result; the result is within the range $<-1 ; 1$). The result may saturate.

The available versions of the [GMCLIB_ElimDcBusRipFOC](#) function are shown in the following table:

Table 2-6. Function versions

Function name	Input type	Output type	Result type
GMCLIB_ElimDcBusRipFOC_F16	frac16_t	GMCLIB_2COOR_ALBE_T_F16 *	void
	GMCLIB_2COOR_ALBE_T_F16 *		

Table continues on the next page...

Table 2-6. Function versions (continued)

Function name	Input type	Output type	Result type
	Compensation of a 16-bit fractional two-phase system input to a 16-bit fractional two-phase system, using a 16-bit fractional DC-bus voltage information. The DC-bus voltage input is within the fractional range <0 ; 1); the stationary (α - β) voltage input and the output are within the fractional range <-1 ; 1).		

2.6.2 Declaration

The available `GMCLIB_ElimDcBusRipFOC` functions have the following declarations:

```
void GMCLIB_ElimDcBusRipFOC_F16(frac16_t f16UDcBus, const GMCLIB_2COOR_ALBE_T_F16 *psUAlBe,
GMCLIB_2COOR_ALBE_T_F16 *psUAlBeComp)
```

2.6.3 Function use

The use of the `GMCLIB_ElimDcBusRipFOC` function is shown in the following example:

```
#include "gmclib.h"

static frac16_t f16UDcBus;
static GMCLIB_2COOR_ALBE_T_F16 sUAlBe;
static GMCLIB_2COOR_ALBE_T_F16 sUAlBeComp;

void Isr(void);

void main(void)
{
    /* Voltage Alpha, Beta structure initialization */
    sUAlBe.f16Alpha = FRAC16(0.0);
    sUAlBe.f16Beta = FRAC16(0.0);

    /* DC bus voltage initialization */
    f16UDcBus = FRAC16(0.8);
}

/* Periodical function or interrupt */
void Isr(void)
{
    /* FOC Ripple elimination calculation */
    GMCLIB_ElimDcBusRipFOC_F16(f16UDcBus, &sUAlBe, &sUAlBeComp);
}
```

2.7 GMCLIB_ElimDcBusRip

The [GMCLIB_ElimDcBusRip](#) function is used for a correct PWM duty cycle output calculation, based on the measured DC-bus voltage. The side effect is the elimination of the the DC-bus voltage ripple in the output PWM duty cycle. This function can be used with any kind of space vector modulation; it has an additional input - the modulation index (with respect to the DC-bus voltage).

The general equation to calculate the duty cycle is as follows:

$$U_{PWM} = \frac{u_{FOC}}{u_{dcbus}} \cdot i_{mod}$$

Equation 22

where:

- U_{PWM} is the duty cycle output
- u_{FOC} is the real FOC voltage
- u_{dcbus} is the real measured DC-bus voltage
- i_{mod} is the space vector modulation index

Using the previous equations, the [GMCLIB_ElimDcBusRip](#) function compensates an amplitude of the direct- α and the quadrature- β component of the stator-reference voltage vector, using the formula shown in the following equations:

$$U_{\alpha}^* = \begin{cases} 0, & U_{\alpha} = 0 \wedge U_{dcbus} = 0 \vee i_{mod} = 0 \\ 1, & U_{\alpha} > 0 \wedge |U_{\alpha}| \geq \frac{U_{dcbus}}{i_{mod}} \wedge i_{mod} > 0 \\ -1, & U_{\alpha} < 0 \wedge |U_{\alpha}| \geq \frac{U_{dcbus}}{i_{mod}} \wedge i_{mod} > 0 \\ \frac{U_{\alpha}}{U_{dcbus}} \cdot i_{mod}, & i_{mod} > 0 \end{cases}$$

Equation 23

$$U_{\beta}^* = \begin{cases} 0, & U_{\beta} = 0 \wedge U_{dcbus} = 0 \vee i_{mod} = 0 \\ 1, & U_{\beta} > 0 \wedge |U_{\beta}| \geq \frac{U_{dcbus}}{i_{mod}} \wedge i_{mod} > 0 \\ -1, & U_{\beta} < 0 \wedge |U_{\beta}| \geq \frac{U_{dcbus}}{i_{mod}} \wedge i_{mod} > 0 \\ \frac{U_{\beta}}{U_{dcbus}} \cdot i_{mod}, & i_{mod} > 0 \end{cases}$$

Equation 24

where:

- U_{α}^* is the direct- α duty cycle ratio
- U_{β}^* is the quadrature- β duty cycle ratio

- U_α is the direct- α voltage
- U_β is the quadrature- β voltage

If the fractional arithmetic is used, the FOC and DC-bus voltages have their scales, which take place in [Equation 22 on page 32](#); the equation is as follows:

$$U_{PWM} = \frac{U_{FOC} \cdot U_{FOC_max}}{U_{dcbus} \cdot U_{dcbus_max}} \cdot i_{mod} = \frac{U_{FOC}}{U_{dcbus}} \cdot \frac{U_{FOC_max}}{U_{dcbus_max}} \cdot i_{mod}$$

Equation 25

where:

- U_{FOC} is the scaled FOC voltage
- U_{dcbus} is the scaled measured DC-bus voltage
- U_{FOC_max} is the FOC voltage scale
- U_{dcbus_max} is the DC-bus voltage scale

Thus, the modulation index in the fractional representation is expressed as follows :

$$i_{modfr} = \frac{U_{FOC_max}}{U_{dcbus_max}} \cdot i_{mod}$$

Equation 26

where:

- i_{modfr} is the space vector modulation index in the fractional arithmetic

The [GMCLIB_ElimDcBusRip](#) function compensates an amplitude of the direct- α and the quadrature- β component of the stator-reference voltage vector in the fractional arithmetic, using the formula shown in the following equations:

$$U_\alpha^* = \begin{cases} 0, & U_\alpha = 0 \wedge U_{dcbus} = 0 \vee i_{modfr} = 0 \\ 1, & U_\alpha > 0 \wedge |U_\alpha| \geq \frac{U_{dcbus}}{i_{modfr}} \wedge i_{modfr} > 0 \\ -1, & U_\alpha < 0 \wedge |U_\alpha| \geq \frac{U_{dcbus}}{i_{modfr}} \wedge i_{modfr} > 0 \\ \frac{U_\alpha}{U_{dcbus}} \cdot i_{modfr}, & i_{modfr} > 0 \end{cases}$$

Equation 27

$$U_\beta^* = \begin{cases} 0, & U_\beta = 0 \wedge U_{dcbus} = 0 \vee i_{modfr} = 0 \\ 1, & U_\beta > 0 \wedge |U_\beta| \geq \frac{U_{dcbus}}{i_{modfr}} \wedge i_{modfr} > 0 \\ -1, & U_\beta < 0 \wedge |U_\beta| \geq \frac{U_{dcbus}}{i_{modfr}} \wedge i_{modfr} > 0 \\ \frac{U_\beta}{U_{dcbus}} \cdot i_{modfr}, & i_{modfr} > 0 \end{cases}$$

Equation 28

where:

- U_{α}^* is the direct- α duty cycle ratio
- U_{β}^* is the quadrature- β duty cycle ratio
- U_{α} is the direct- α voltage
- U_{β} is the quadrature- β voltage

The [GMCLIB_ElimDcBusRip](#) function can be used in general motor-control applications, and it provides elimination of the voltage ripple on the DC-bus of the power stage. [Figure 2-4](#) shows the results of the DC-bus ripple elimination, while compensating the ripples of the rectified voltage, using a three-phase uncontrolled rectifier.

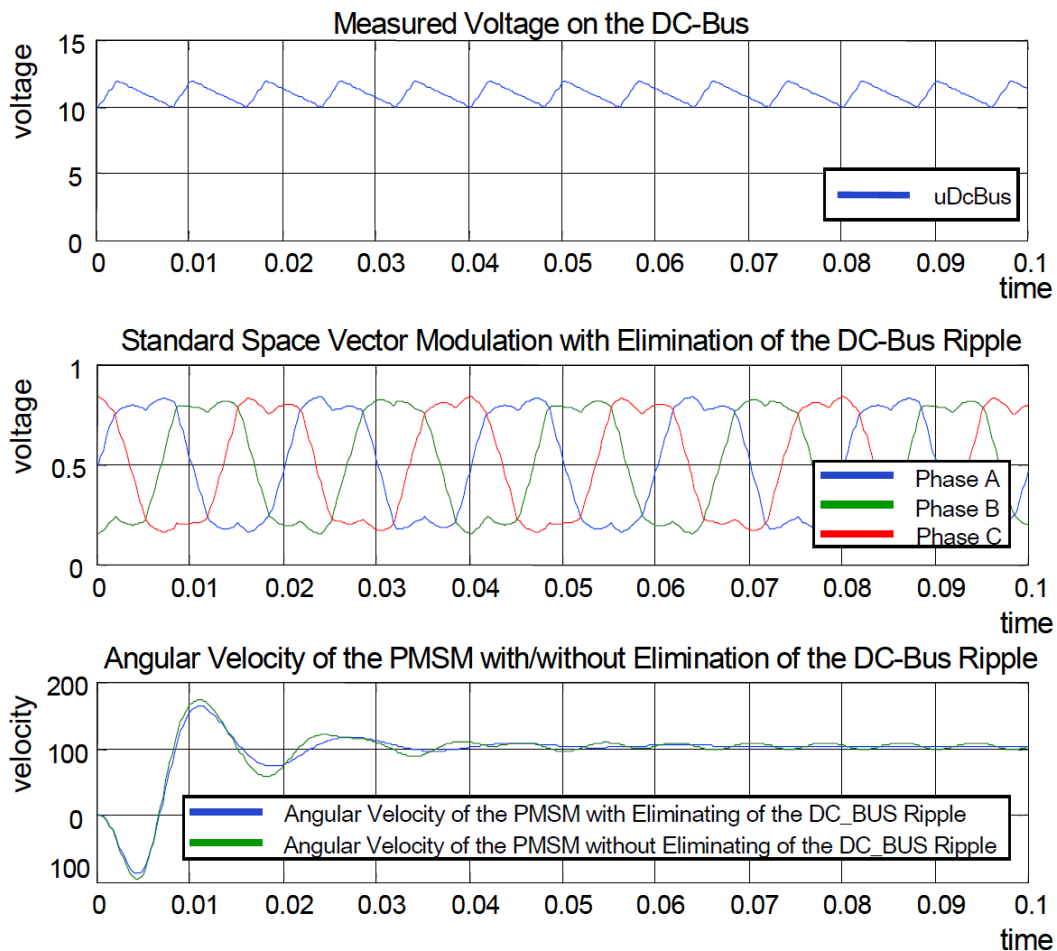

Figure 2-4. Results of the DC-bus voltage ripple elimination

2.7.1 Available versions

This function is available in the following versions:

- Fractional output - the output is the fractional portion of the result; the result is within the range $<-1 ; 1)$. The result may saturate. The modulation index is a non-negative accumulator type value.

The available versions of the [GMCLIB_ElimDcBusRip](#) function are shown in the following table:

Table 2-7. Function versions

Function name	Input type	Output type	Result type
GMCLIB_ElimDcBusRip_F16sas	frac16_t	GMCLIB_2COOR_ALBE_T_F16 *	void
	acc32_t		
	GMCLIB_2COOR_ALBE_T_F16 *		
Compensation of a 16-bit fractional two-phase system input to a 16-bit fractional two-phase system using a 16-bit fractional DC-bus voltage information and a 32-bit accumulator modulation index. The DC-bus voltage input is within the fractional range $<0 ; 1)$; the modulation index is a non-negative value; the stationary (α - β) voltage input and output are within the fractional range $<-1 ; 1)$.			

2.7.2 Declaration

The available [GMCLIB_ElimDcBusRip](#) functions have the following declarations:

```
void GMCLIB_ElimDcBusRip_F16sas(frac16\_t f16UDcBus, acc32\_t a32IdxMod, const
GMCLIB\_2COOR\_ALBE\_T\_F16 *psUAlBeComp, GMCLIB\_2COOR\_ALBE\_T\_F16 *psUAlBe)
```

2.7.3 Function use

The use of the [GMCLIB_ElimDcBusRip](#) function is shown in the following example:

```
#include "gmclib.h"

static frac16\_t f16UDcBus;
static acc32\_t a32IdxMod;
static GMCLIB\_2COOR\_ALBE\_T\_F16 sUAlBe;
static GMCLIB\_2COOR\_ALBE\_T\_F16 sUAlBeComp;

void Isr(void);

void main(void)
{
    /* Voltage Alpha, Beta structure initialization */
    sUAlBe.f16Alpha = FRAC16(0.0);
    sUAlBe.f16Beta = FRAC16(0.0);
```

```
/* SVM modulation index */
a32IdxMod = ACC32(1.3);

/* DC bus voltage initialization */
f16UDcBus = FRAC16(0.8);
}

/* Periodical function or interrupt */
void Isr(void)
{
/* Ripple elimination calculation */
GMCLIB_ElimDcBusRip_F16sas(f16UDcBus, a32IdxMod, &sUAlBe, &sUAlBeComp);
}
}
```

2.8 GMCLIB_SvmStd

The [GMCLIB_SvmStd](#) function calculates the appropriate duty-cycle ratios, which are needed for generation of the given stator-reference voltage vector, using a special standard space vector modulation technique.

The [GMCLIB_SvmStd](#) function for calculating the duty-cycle ratios is widely used in modern electric drives. This function calculates the appropriate duty-cycle ratios, which are needed for generating the given stator reference voltage vector, using a special space vector modulation technique, called standard space vector modulation.

The basic principle of the standard space vector modulation technique can be explained using the power stage diagram shown in [Figure 2-5](#).

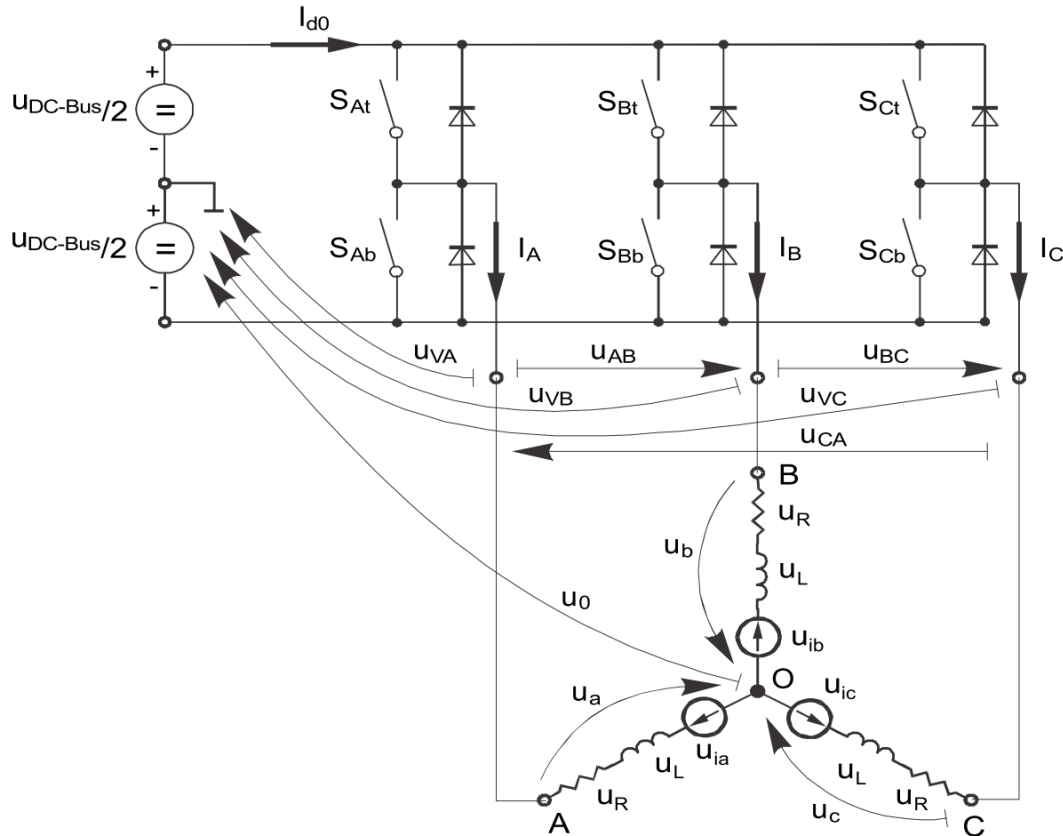

Figure 2-5. Power stage schematic diagram

The top and bottom switches are working in a complementary mode; for example, if the top switch S_{At} is on, then the corresponding bottom switch S_{Ab} is off, and vice versa. Considering that the value 1 is assigned to the ON state of the top switch, and value 0 is assigned to the ON state of the bottom switch, the switching vector $[a, b, c]^T$ can be defined. Creating of such vector allows for numerical definition of all possible switching states. Phase-to-phase voltages can then be expressed in terms of the following states:

$$\begin{bmatrix} U_{AB} \\ U_{BC} \\ U_{CA} \end{bmatrix} = U_{DCBus} \begin{bmatrix} 1 & -1 & 0 \\ 0 & 1 & -1 \\ -1 & 0 & 1 \end{bmatrix} \cdot \begin{bmatrix} a \\ b \\ c \end{bmatrix}$$

Equation 29

where U_{DCBus} is the instantaneous voltage measured on the DC-bus.

Assuming that the motor is completely symmetrical, it is possible to write a matrix equation, which expresses the motor phase voltages shown in [Equation 29 on page 37](#).

$$\begin{bmatrix} U_a \\ U_b \\ U_c \end{bmatrix} = \frac{U_{DCBus}}{3} \begin{bmatrix} 2 & -1 & -1 \\ -1 & 2 & -1 \\ -1 & -1 & 2 \end{bmatrix} \cdot \begin{bmatrix} a \\ b \\ c \end{bmatrix}$$

Equation 30

In a three-phase power stage configuration (as shown in [Figure 2-5](#)), eight possible switching states (shown in [Figure 2-6](#)) are feasible. These states, together with the resulting instantaneous output line-to-line and phase voltages, are listed in [Table 2-8](#).

Table 2-8. Switching patterns

A	B	C	U_a	U_b	U_c	U_{AB}	U_{BC}	U_{CA}	Vector
0	0	0	0	0	0	0	0	0	O_{000}
1	0	0	$2U_{DCBus}/3$	$-U_{DCBus}/3$	$-U_{DCBus}/3$	U_{DCBus}	0	$-U_{DCBus}$	U_0
1	1	0	$U_{DCBus}/3$	$U_{DCBus}/3$	$-2U_{DCBus}/3$	0	U_{DCBus}	$-U_{DCBus}$	U_{60}
0	1	0	$-U_{DCBus}/3$	$2U_{DCBus}/3$	$-U_{DCBus}/3$	$-U_{DCBus}$	U_{DCBus}	0	U_{120}
0	1	1	$-2U_{DCBus}/3$	$U_{DCBus}/3$	$U_{DCBus}/3$	$-U_{DCBus}$	0	U_{DCBus}	U_{240}
0	0	1	$-U_{DCBus}/3$	$-U_{DCBus}/3$	$2U_{DCBus}/3$	0	$-U_{DCBus}$	U_{DCBus}	U_{300}
1	0	1	$U_{DCBus}/3$	$-2U_{DCBus}/3$	$U_{DCBus}/3$	U_{DCBus}	$-U_{DCBus}$	0	U_{360}
1	1	1	0	0	0	0	0	0	O_{111}

The quantities of the direct- α and the quadrature- β components of the two-phase orthogonal coordinate system, describing the three-phase stator voltages, are expressed using the Clark transformation, arranged in a matrix form:

$$\begin{bmatrix} U_\alpha \\ U_\beta \end{bmatrix} = \frac{2}{3} \begin{bmatrix} 1 & -\frac{1}{2} & -\frac{1}{2} \\ 0 & \frac{\sqrt{3}}{2} & -\frac{\sqrt{3}}{2} \end{bmatrix} \cdot \begin{bmatrix} U_a \\ U_b \\ U_c \end{bmatrix}$$

Equation 31

The three-phase stator voltages - U_a , U_b , and U_c , are transformed using the Clark transformation into the direct- α and the quadrature- β components of the two-phase orthogonal coordinate system. The transformation results are listed in [Table 2-9](#).

Table 2-9. Switching patterns and space vectors

A	B	C	U_α	U_β	Vector
0	0	0	0	0	O_{000}
1	0	0	$2U_{DCBus}/3$	0	U_0
1	1	0	$U_{DCBus}/3$	$U_{DCBus}/\sqrt{3}$	U_{60}
0	1	0	$-U_{DCBus}/3$	$U_{DCBus}/\sqrt{3}$	U_{120}
0	1	1	$-2U_{DCBus}/3$	0	U_{240}
0	0	1	$-U_{DCBus}/3$	$-U_{DCBus}/\sqrt{3}$	U_{300}
1	0	1	$U_{DCBus}/3$	$-U_{DCBus}/\sqrt{3}$	U_{360}
1	1	1	0	0	O_{111}

Figure 2-6 depicts the basic feasible switching states (vectors). There are six nonzero vectors - $U_0, U_{60}, U_{120}, U_{180}, U_{240},$ and U_{300} , and two zero vectors - O_{111} and O_{000} , usable for switching. Therefore, the principle of the standard space vector modulation lies in applying the appropriate switching states for a certain time, and thus generating a voltage vector identical to the reference one.

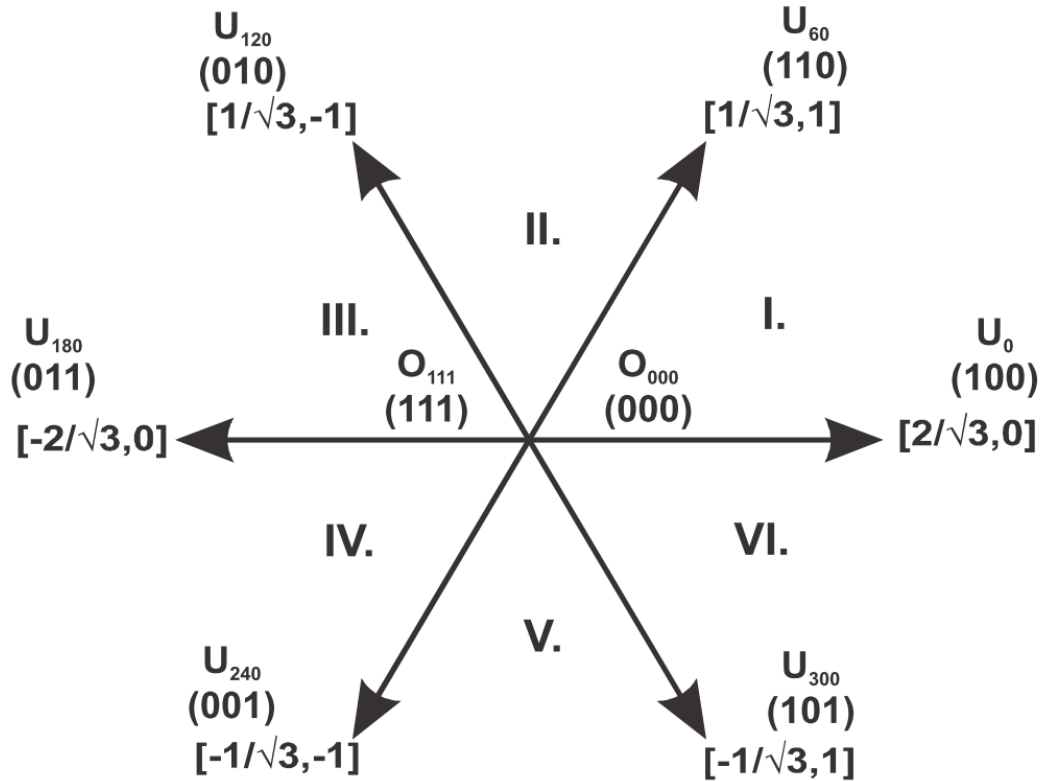

Figure 2-6. Basic space vectors

Referring to this principle, the objective of the standard space vector modulation is an approximation of the reference stator voltage vector U_S , with an appropriate combination of the switching patterns, composed of basic space vectors. The graphical explanation of this objective is shown in Figure 2-7 and Figure 2-8.

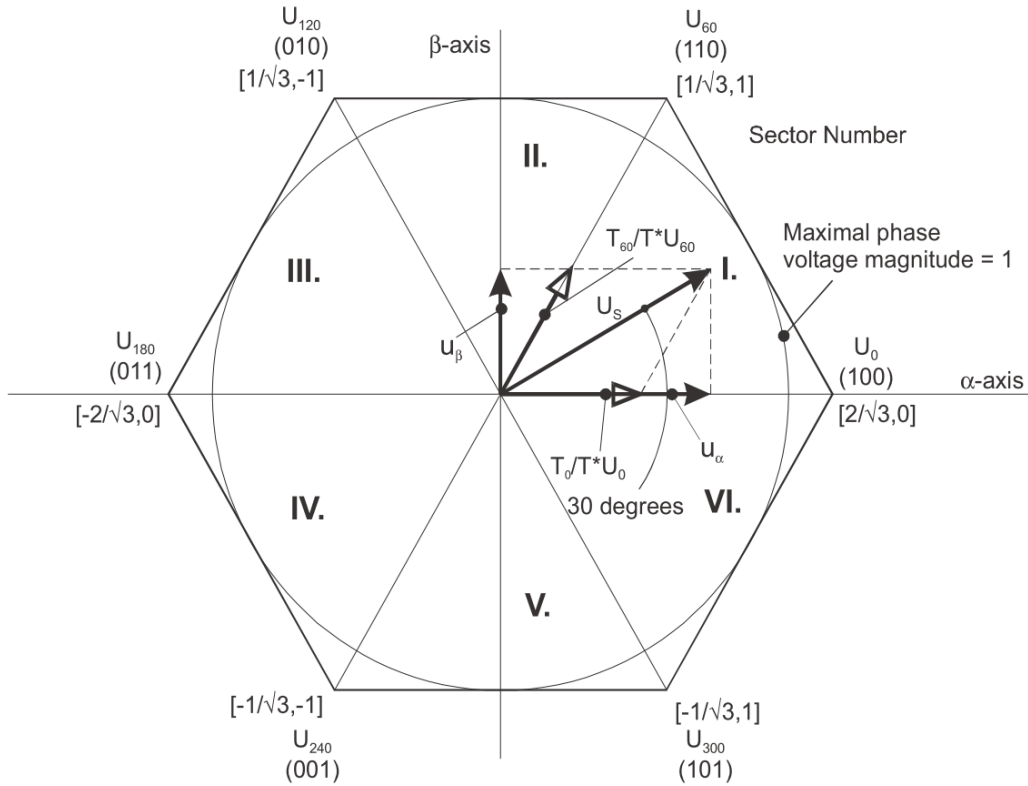

Figure 2-7. Projection of reference voltage vector in the respective sector

The stator reference voltage vector U_s is phase-advanced by 30° from the direct- α , and thus can be generated with an appropriate combination of the adjacent basic switching states U_0 and U_{60} . These figures also indicate the resultant direct- α and quadrature- β components for space vectors U_0 and U_{60} .

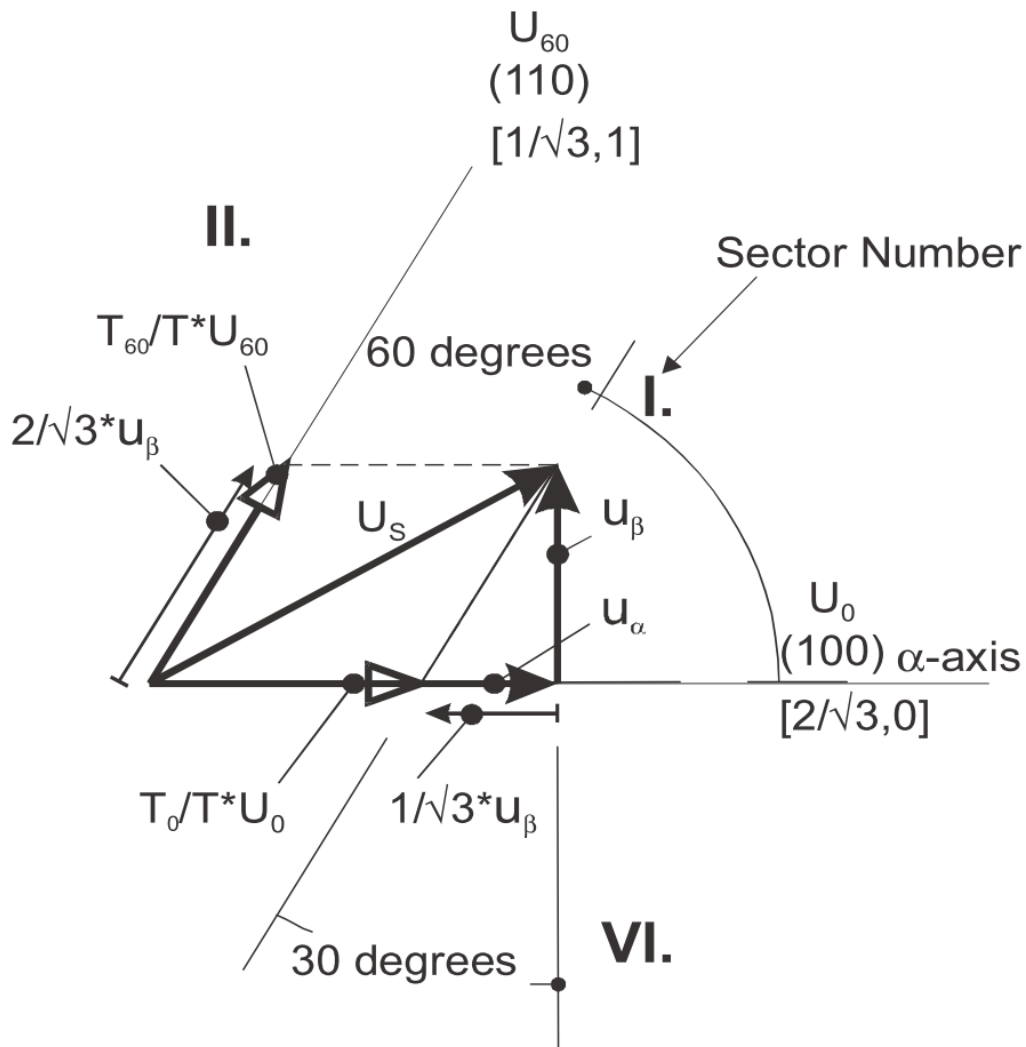

Figure 2-8. Detail of the voltage vector projection in the respective sector

In this case, the reference stator voltage vector U_S is located in sector I, and can be generated using the appropriate duty-cycle ratios of the basic switching states U_0 and U_{60} . The principal equations concerning this vector location are as follows:

$$T = T_{60} + T_0 + T_{null}$$

$$U_S = \frac{T_{60}}{T} \cdot U_{60} + \frac{T_0}{T} \cdot U_0$$

Equation 32

where T_{60} and T_0 are the respective duty-cycle ratios, for which the basic space vectors T_{60} and T_0 should be applied within the time period T . T_{null} is the time, for which the null vectors O_{000} and O_{111} are applied. Those duty-cycle ratios can be calculated using the following equations:

$$u_{\beta} = \frac{T_{60}}{T} \cdot |U_{60}| \cdot \sin 60^{\circ}$$

$$u_{\alpha} = \frac{T_0}{T} \cdot |U_d| + \frac{u_{\beta}}{\tan 60^{\circ}}$$

Equation 33

Considering that normalized magnitudes of basic space vectors are $|U_{60}| = |U_0| = 2 / \sqrt{3}$, and by the substitution of the trigonometric expressions $\sin 60^{\circ}$ and $\tan 60^{\circ}$ by their quantities $2 / \sqrt{3}$, and $\sqrt{3}$, respectively, the [Equation 33 on page 42](#) can be rearranged for the unknown duty-cycle ratios T_{60} / T and T_0 / T as follows:

$$\frac{T_{60}}{T} = u_{\beta}$$

$$U_S = \frac{T_{120}}{T} \cdot U_{120} + \frac{T_{60}}{T} \cdot U_{60}$$

Equation 34

Sector II is depicted in [Figure 2-9](#). In this particular case, the reference stator voltage vector U_S is generated using the appropriate duty-cycle ratios of the basic switching states T_{60} and T_{120} . The basic equations describing this sector are as follows:

$$T = T_{120} + T_{60} + T_{null}$$

$$U_S = \frac{T_{120}}{T} \cdot U_{120} + \frac{T_{60}}{T} \cdot U_{60}$$

Equation 35

where T_{120} and T_{60} are the respective duty-cycle ratios, for which the basic space vectors U_{120} and U_{60} should be applied within the time period T . T_{null} is the time, for which the null vectors O_{000} and O_{111} are applied. These resultant duty-cycle ratios are formed from the auxiliary components, termed A and B. The graphical representation of the auxiliary components is shown in [Figure 2-10](#).

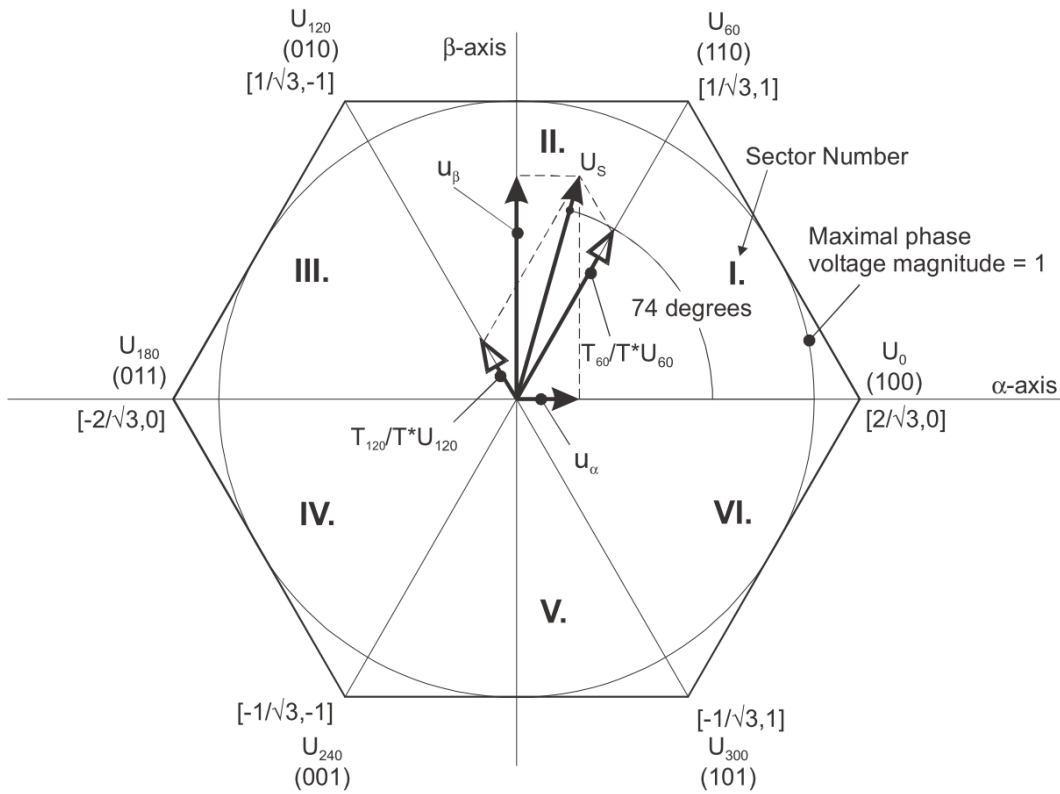

Figure 2-9. Projection of the reference voltage vector in the respective sector

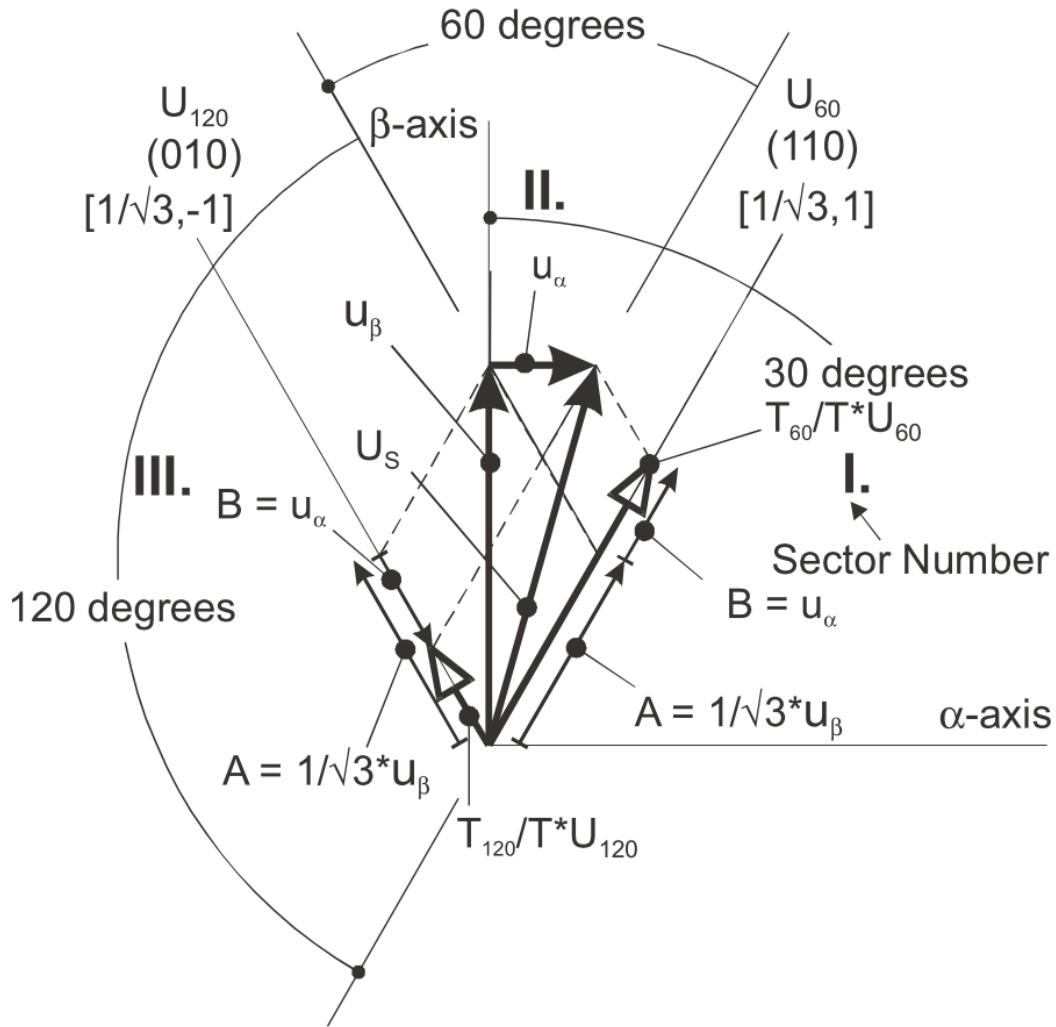

Figure 2-10. Detail of the voltage vector projection in the respective sector

The equations describing those auxiliary time-duration components are as follows:

$$\frac{\sin 30^\circ}{\sin 120^\circ} = \frac{A}{u_\beta}$$

$$\frac{\sin 60^\circ}{\sin 60^\circ} = \frac{B}{u_\alpha}$$

Equation 36

Equations in [Equation 36 on page 44](#) have been created using the sine rule.

The resultant duty-cycle ratios T_{120} / T and T_{60} / T are then expressed in terms of the auxiliary time-duration components, defined by [Equation 37 on page 44](#) as follows:

$$A = \frac{1}{\sqrt{3}} \cdot u_\beta$$

$$B = u_\alpha$$

Equation 37

Using these equations, and also considering that the normalized magnitudes of the basic space vectors are $|U_{120}| = |U_{60}| = 2 / \sqrt{3}$, the equations expressed for the unknown duty-cycle ratios of basic space vectors T_{120} / T and T_{60} / T can be expressed as follows:

$$\begin{aligned}\frac{T_{120}}{T} \cdot |U_{120}| &= (A - B) \\ \frac{T_{60}}{T} \cdot |U_{60}| &= (A + B)\end{aligned}$$

Equation 38

The duty-cycle ratios in the remaining sectors can be derived using the same approach. The resulting equations will be similar to those derived for sector I and sector II.

$$\begin{aligned}\frac{T_{120}}{T} &= \frac{1}{2}(u_{\beta} - \sqrt{3} \cdot u_{\alpha}) \\ \frac{T_{60}}{T} &= \frac{1}{2}(u_{\beta} + \sqrt{3} \cdot u_{\alpha})\end{aligned}$$

Equation 39

To depict the duty-cycle ratios of the basic space vectors for all sectors, we define:

- Three auxiliary variables:

$$\begin{aligned}X &= u_{\beta} \\ Y &= \frac{1}{2}(u_{\beta} + \sqrt{3} \cdot u_{\alpha}) \\ Z &= \frac{1}{2}(u_{\beta} - \sqrt{3} \cdot u_{\alpha})\end{aligned}$$

Equation 40

- Two expressions - t_1 and t_2 , which generally represent the duty-cycle ratios of the basic space vectors in the respective sector (for example, for the first sector, t_1 and t_2), represent duty-cycle ratios of the basic space vectors U_{60} and U_0 ; for the second sector, t_1 and t_2 represent duty-cycle ratios of the basic space vectors U_{120} and U_{60} , and so on.

The expressions t_1 and t_2 , in terms of auxiliary variables X, Y, and Z for each sector, are listed in [Table 2-10](#).

Table 2-10. Determination of t_1 and t_2 expressions

Sectors	U_0, U_{60}	U_{60}, U_{120}	U_{120}, U_{180}	U_{180}, U_{240}	U_{240}, U_{300}	U_{300}, U_0
t_1	X	Y	-Y	Z	-Z	-X
t_2	-Z	Z	X	-X	-Y	Y

For the determination of auxiliary variables X, Y, and Z, the sector number is required. This information can be obtained using several approaches. The approach discussed here requires the use of modified Inverse Clark transformation to transform the direct- α and quadrature- β components into balanced three-phase quantities u_{ref1} , u_{ref2} , and u_{ref3} , used for straightforward calculation of the sector number, to be shown later.

$$\begin{aligned}
 u_{ref1} &= u_{\beta} \\
 u_{ref2} &= \frac{-u_{\beta} + \sqrt{3}u_{\alpha}}{2} \\
 u_{ref3} &= \frac{-u_{\beta} - \sqrt{3}u_{\alpha}}{2}
 \end{aligned}$$

Equation 41

The modified Inverse Clark transformation projects the quadrature- u_{β} component into u_{ref1} , as shown in [Figure 2-11](#) and [Figure 2-12](#), whereas voltages generated by the conventional Inverse Clark transformation project the direct- u_{α} component into u_{ref1} .

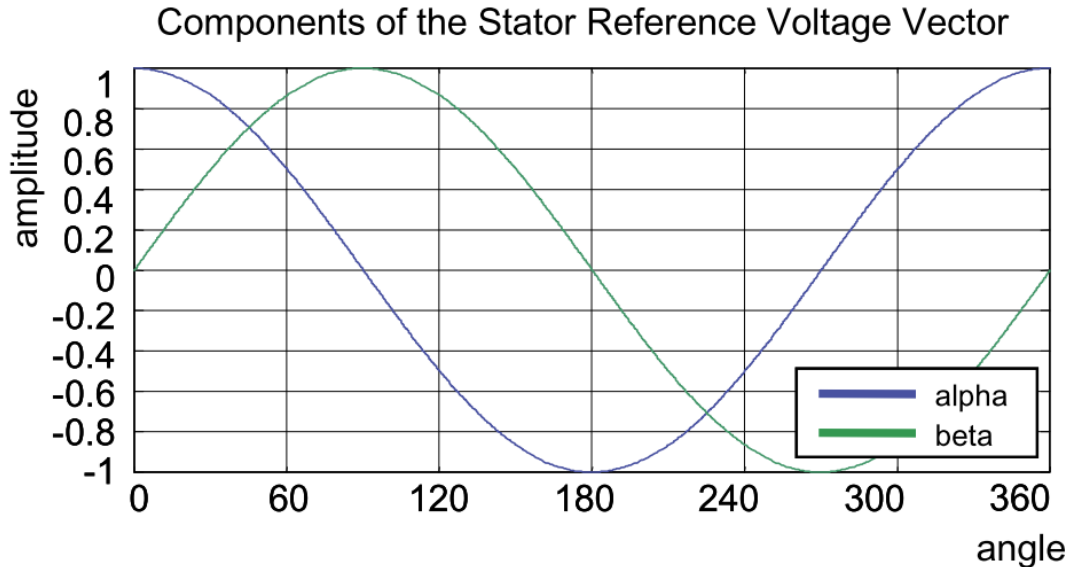

Figure 2-11. Direct- u_{α} and quadrature- u_{β} components of the stator reference voltage

[Figure 2-11](#) depicts the direct- u_{α} and quadrature- u_{β} components of the stator reference voltage vector U_S , which were calculated using equations $u_{\alpha} = \cos \vartheta$ and $u_{\beta} = \sin \vartheta$, respectively.

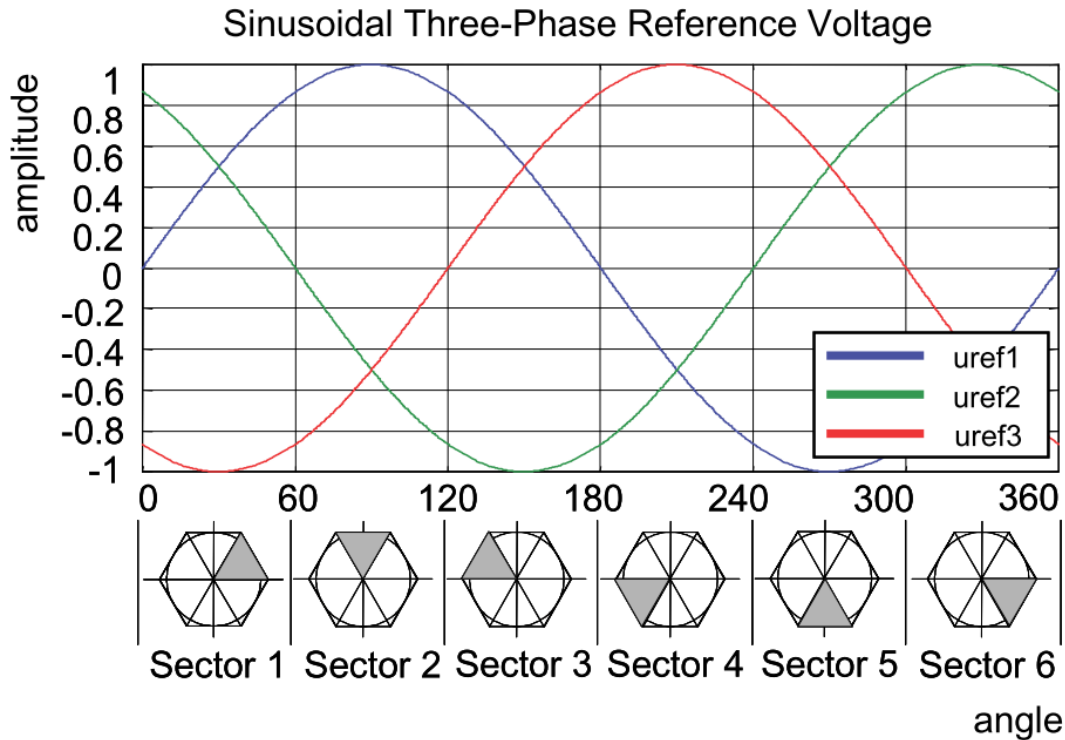

Figure 2-12. Reference voltages U_{ref1} , U_{ref2} , and U_{ref3}

The sector identification tree shown in [Figure 2-13](#) can be a numerical solution of the approach shown in [GMCLIB_SvmStd_Img8](#).

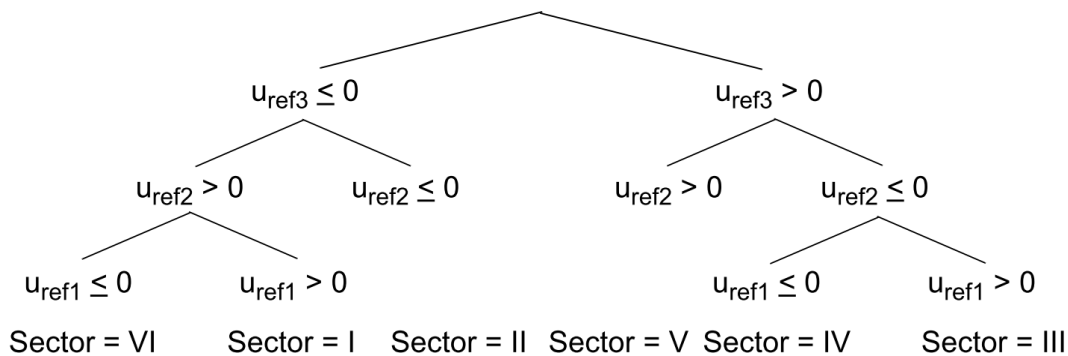

Figure 2-13. Identification of the sector number

In the worst case, at least three simple comparisons are required to precisely identify the sector of the stator reference voltage vector. For example, if the stator reference voltage vector is located as shown in [Figure 2-7](#), the stator-reference voltage vector is phase-advanced by 30° from the direct α -axis, which results in the positive quantities of u_{ref1} and u_{ref2} , and the negative quantity of u_{ref3} ; see [Figure 2-12](#). If these quantities are used as the inputs for the sector identification tree, the product of those comparisons will be sector I. The same approach identifies sector II, if the stator-reference voltage vector is

located as shown in [Figure 2-9](#). The variables t_1 , t_2 , and t_3 , which represent the switching duty-cycle ratios of the respective three-phase system, are calculated according to the following equations:

$$\begin{aligned}t_1 &= \frac{T-t_{-1}-t_{-2}}{2} \\t_2 &= t_1+t_{-1} \\t_3 &= t_2+t_{-2}\end{aligned}$$

Equation 42

where T is the switching period, and t_{-1} and t_{-2} are the duty-cycle ratios of the basic space vectors given for the respective sector; [Table 2-10](#), [Equation 31 on page 38](#), and [Equation 42 on page 48](#) are specific solely to the standard space vector modulation technique; other space vector modulation techniques discussed later will require deriving different equations.

The next step is to assign the correct duty-cycle ratios - t_1 , t_2 , and t_3 , to the respective motor phases. This is a simple task, accomplished in a view of the position of the stator reference voltage vector; see [Table 4](#).

Table 2-11. Assignment of the duty-cycle ratios to motor phases

Sectors	U_0, U_{60}	U_{60}, U_{120}	U_{120}, U_{180}	U_{180}, U_{240}	U_{240}, U_{300}	U_{300}, U_0
pwm_a	t_3	t_2	t_1	t_1	t_2	t_3
pwm_b	t_2	t_3	t_3	t_2	t_1	t_1
pwm_c	t_1	t_1	t_2	t_3	t_3	t_2

The principle of the space vector modulation technique consists of applying the basic voltage vectors U_{XXX} and O_{XXX} for certain time, in such a way that the main vector generated by the pulse width modulation approach for the period T is equal to the original stator reference voltage vector U_S . This provides a great variability of arrangement of the basic vectors during the PWM period T . These vectors might be arranged either to lower the switching losses, or to achieve diverse results, such as center-aligned PWM, edge-aligned PWM, or a minimal number of switching states. A brief discussion of the widely used center-aligned PWM follows.

Generating the center-aligned PWM pattern is accomplished by comparing the threshold levels `pwm_a`, `pwm_b`, and `pwm_c` with a free-running up-down counter. The timer counts to one, and then down to zero. It is supposed that when a threshold level is larger than the timer value, the respective PWM output is active. Otherwise, it is inactive; see [Figure 2-14](#).

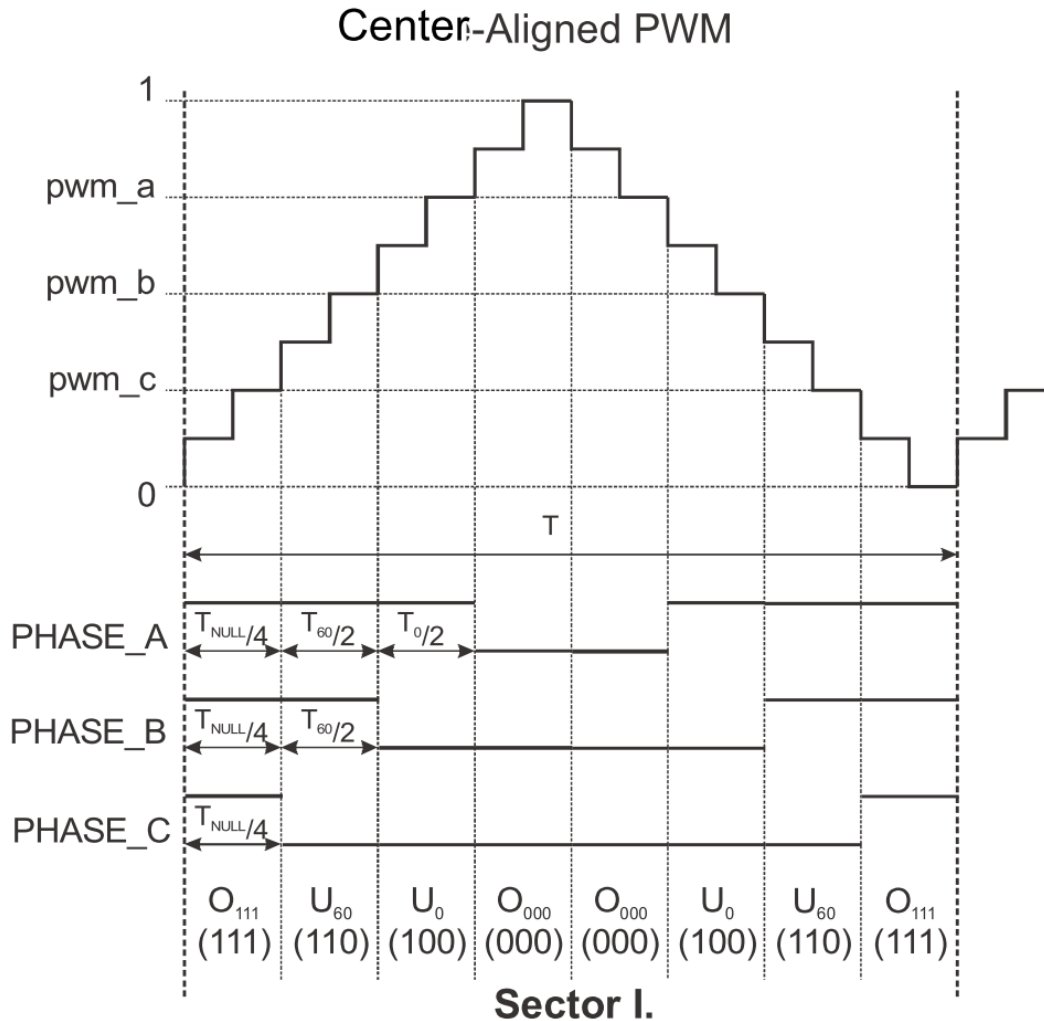

Figure 2-14. Standard space vector modulation technique — center-aligned PWM

Figure 2-15 shows the waveforms of the duty-cycle ratios, calculated using standard space vector modulation.

For the accurate calculation of the duty-cycle ratios, direct- α , and quadrature- β components of the stator reference voltage vector, it must be considered that the duty cycle cannot be higher than one (100 %); in other words, the assumption $\sqrt{\alpha^2 + \beta^2} \leq 1$ must be met.

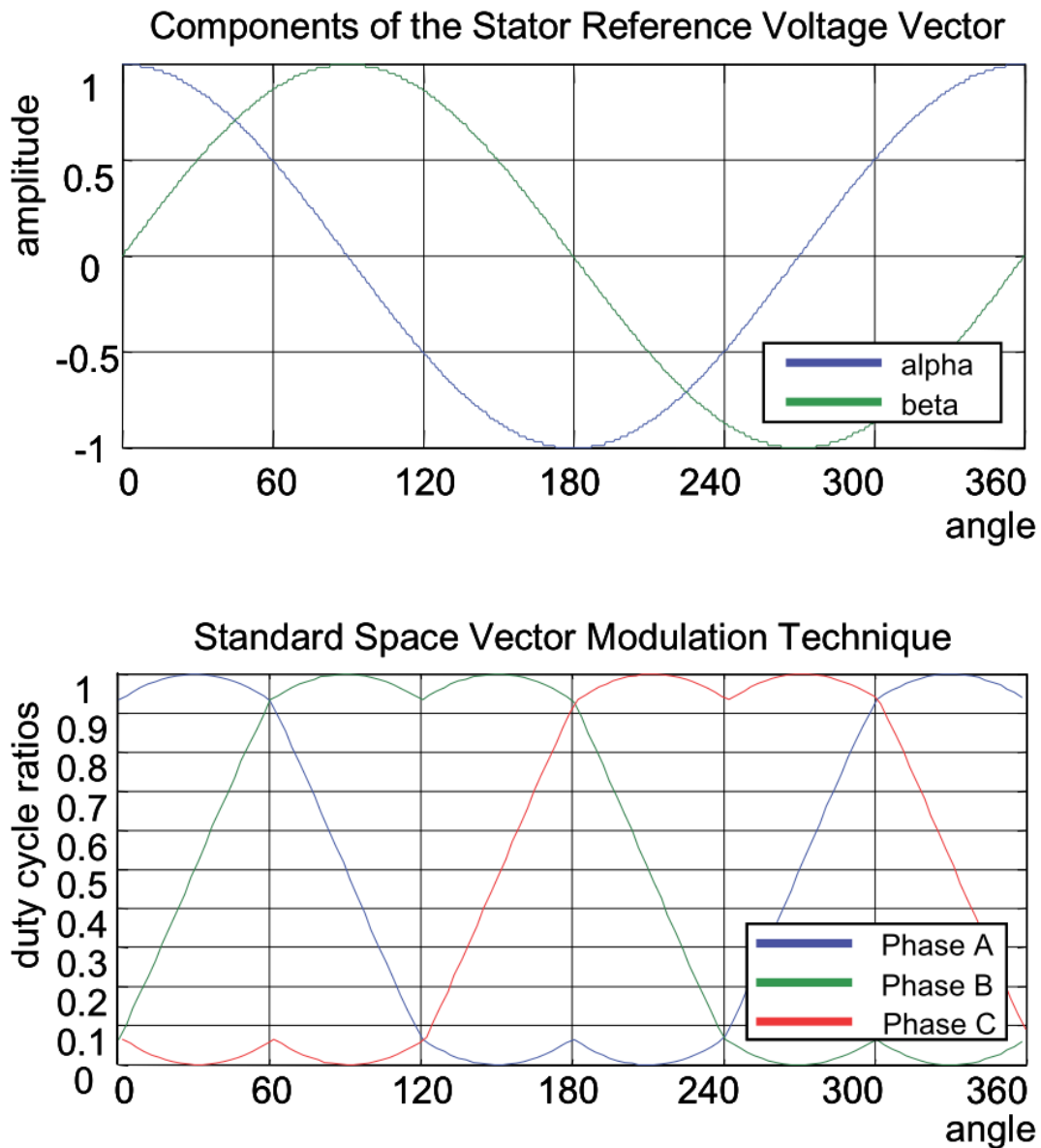

Figure 2-15. Standard space vector modulation technique

2.8.1 Available versions

This function is available in the following versions:

- Fractional output - the output is the fractional portion of the result; the result is within the range $<0 ; 1)$. The result may saturate.

The available versions of the [GMCLIB_SvmStd](#) function are shown in the following table.

Table 2-12. Function versions

Function name	Input type	Output type	Result type
GMCLIB_SvmStd_F16	GMCLIB_2COOR_ALBE_T_F16 *	GMCLIB_3COOR_T_F16 *	uint16_t
	Standard space vector modulation with a 16-bit fractional stationary (α - β) input and a 16-bit fractional three-phase output. The result type is a 16-bit unsigned integer, which indicates the actual SVM sector. The input is within the range $\langle -1 ; 1 \rangle$; the output duty cycle is within the range $\langle 0 ; 1 \rangle$. The output sector is an integer value within the range $\langle 1 ; 6 \rangle$.		

2.8.2 Declaration

The available [GMCLIB_SvmStd](#) functions have the following declarations:

```
uint16_t GMCLIB_SvmStd_F16(const GMCLIB_2COOR_ALBE_T_F16 *psIn, GMCLIB_3COOR_T_F16 *psOut)
```

2.8.3 Function use

The use of the [GMCLIB_SvmStd](#) function is shown in the following example:

```
#include "gmclib.h"

static uint16_t u16Sector;
static GMCLIB_2COOR_ALBE_T_F16 sAlphaBeta;
static GMCLIB_3COOR_T_F16 sAbc;

void Isr(void);

void main(void)
{
    /* Alpha, Beta structure initialization */
    sAlphaBeta.f16Alpha = FRAC16(0.0);
    sAlphaBeta.f16Beta = FRAC16(0.0);
}

/* Periodical function or interrupt */
void Isr(void)
{
    /* SVM calculation */
    u16Sector = GMCLIB_SvmStd_F16(&sAlphaBeta, &sAbc);
}
```

2.9 GMCLIB_SvmIct

The [GMCLIB_SvmIct](#) function calculates the appropriate duty-cycle ratios, which are needed for generation of the given stator-reference voltage vector using the general sinusoidal modulation technique.

The [GMCLIB_SvmIct](#) function calculates the appropriate duty-cycle ratios, needed for generation of the given stator reference voltage vector using the conventional Inverse Clark transformation. Finding the sector in which the reference stator voltage vector U_S resides is similar to [GMCLIB_SvmStd](#). This is achieved by first converting the direct- α and the quadrature- β components of the reference stator voltage vector U_S into the balanced three-phase quantities u_{ref1} , u_{ref2} , and u_{ref3} using the modified Inverse Clark transformation:

$$\begin{aligned} u_{ref1} &= u_\beta \\ u_{ref2} &= \frac{-u_\beta + \sqrt{3}u_\alpha}{2} \\ u_{ref3} &= \frac{-u_\beta - \sqrt{3}u_\alpha}{2} \end{aligned}$$

Equation 43

The calculation of the sector number is based on comparing the three-phase reference voltages u_{ref1} , u_{ref2} , and u_{ref3} with zero. This computation is described by the following set of rules:

$$\begin{aligned} a &= \begin{cases} 1, & u_{ref1} > 0 \\ 0, & \text{else} \end{cases} \\ b &= \begin{cases} 2, & u_{ref2} > 0 \\ 0, & \text{else} \end{cases} \\ c &= \begin{cases} 4, & u_{ref3} > 0 \\ 0, & \text{else} \end{cases} \end{aligned}$$

Equation 44

After passing these rules, the modified sector numbers are then derived using the following formula:

$$sector^* = a + b + c$$

Equation 45

The sector numbers determined by this formula must be further transformed to correspond to those determined by the sector identification tree. The transformation which meets this requirement is shown in the following table:

Table 2-13. Transformation of the sectors

Sector*	1	2	3	4	5	6
Sector	2	6	1	4	3	5

Use the Inverse Clark transformation for transforming values such as flux, voltage, and current from an orthogonal rotating coordination system (u_α , u_β) to a three-phase rotating coordination system (u_a , u_b , and u_c). The original equations of the Inverse Clark transformation are scaled here to provide the duty-cycle ratios in the range $<0 ; 1$). These scaled duty cycle ratios pwm_a , pwm_b , and pwm_c can be used directly by the registers of the PWM block.

$$pwm_a = 0.5 + \frac{u_\alpha}{2}$$

$$pwm_b = 0.5 + \frac{-u_\alpha + \sqrt{3}u_\beta}{4}$$

$$pwm_c = 0.5 + \frac{-u_\alpha - \sqrt{3}u_\beta}{4}$$

Equation 46

The following figure shows the waveforms of the duty-cycle ratios calculated using the Inverse Clark transformation.

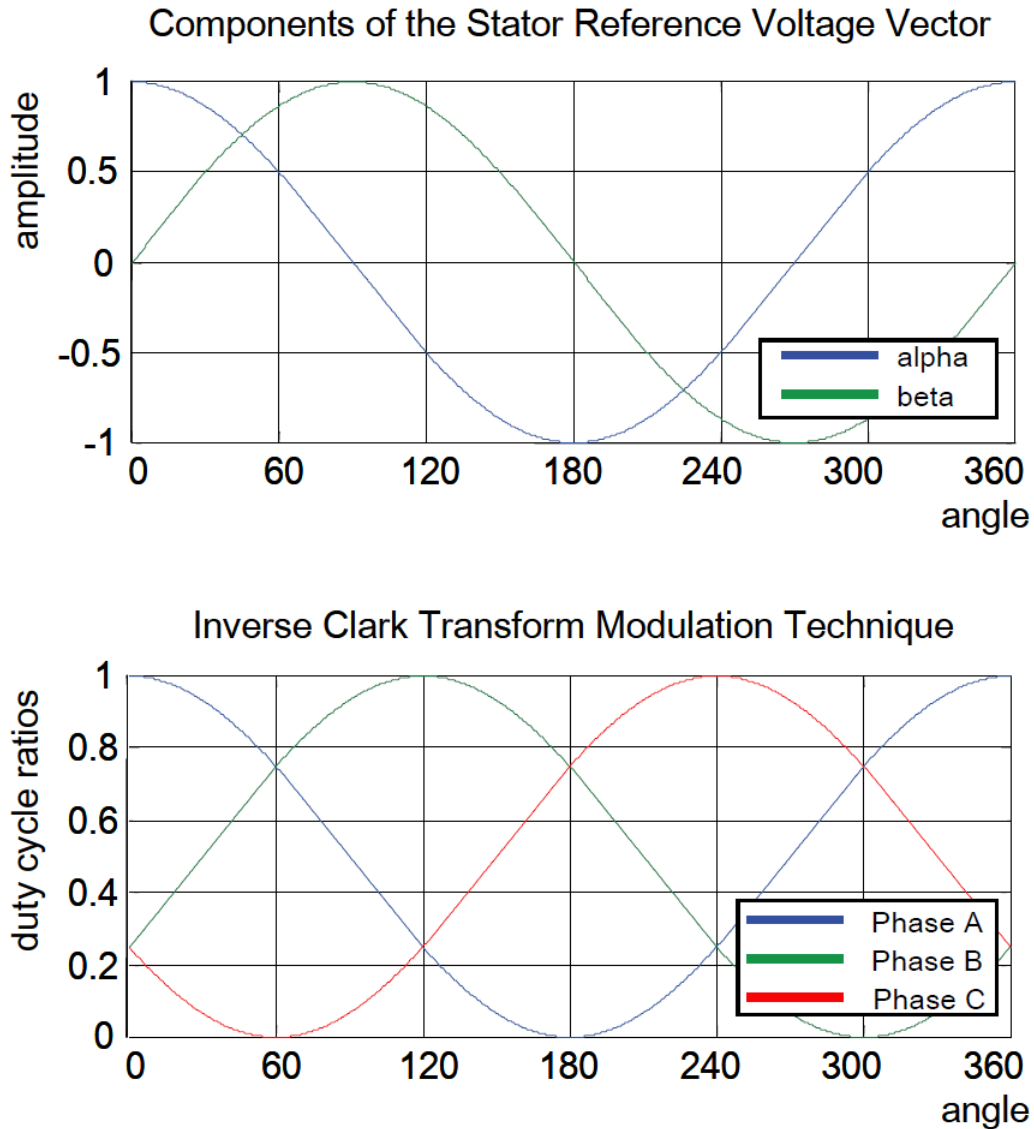

Figure 2-16. Inverse Clark transform modulation technique

For an accurate calculation of the duty-cycle ratios and the direct- α and quadrature- β components of the stator reference voltage vector, the duty cycle cannot be higher than one (100 %); in other words, the assumption $\sqrt{\alpha^2 + \beta^2} \leq 1$ must be met.

2.9.1 Available versions

This function is available in the following versions:

- Fractional output - the output is the fractional portion of the result; the result is within the range $<0 ; 1$). The result may saturate.

The available versions of the [GMCLIB_SvmIct](#) function are shown in the following table:

Table 2-14. Function versions

Function name	Input type	Output type	Result type
GMCLIB_SvmIct_F16	GMCLIB_2COOR_ALBE_T_F16 *	GMCLIB_3COOR_T_F16 *	uint16_t
	General sinusoidal space vector modulation with a 16-bit fractional stationary (α - β) input and a 16-bit fractional three-phase output. The result type is a 16-bit unsigned integer, which indicates the actual SVM sector. The input is within the range $\langle -1 ; 1 \rangle$; the output duty cycle is within the range $\langle 0 ; 1 \rangle$. The output sector is an integer value within the range $\langle 1 ; 6 \rangle$.		

2.9.2 Declaration

The available [GMCLIB_SvmIct](#) functions have the following declarations:

```
uint16_t GMCLIB_SvmIct_F16(const GMCLIB_2COOR_ALBE_T_F16 *psIn, GMCLIB_3COOR_T_F16 *psOut)
```

2.9.3 Function use

The use of the [GMCLIB_SvmIct](#) function is shown in the following example:

```
#include "gmclib.h"

static uint16_t u16Sector;
static GMCLIB_2COOR_ALBE_T_F16 sAlphaBeta;
static GMCLIB_3COOR_T_F16 sAbc;

void Isr(void);

void main(void)
{
    /* Alpha, Beta structure initialization */
    sAlphaBeta.f16Alpha = FRAC16(0.0);
    sAlphaBeta.f16Beta = FRAC16(0.0);
}

/* Periodical function or interrupt */
void Isr(void)
{
    /* SVM calculation */
    u16Sector = GMCLIB_SvmIct_F16(&sAlphaBeta, &sAbc);
}
```

2.10 GMCLIB_SvmU0n

The [GMCLIB_SvmU0n](#) function calculates the appropriate duty-cycle ratios, which are needed for generation of the given stator-reference voltage vector using the general sinusoidal modulation technique.

The [GMCLIB_SvmU0n](#) function for calculating of duty-cycle ratios is widely used in modern electric drives. This function calculates the appropriate duty-cycle ratios, which are needed for generating the given stator reference voltage vector using a special space vector modulation technique called space vector modulation with O_{000} nulls, where only one type of null vector O_{000} is used (all bottom switches are turned on in the inverter).

The derivation approach of the space vector modulation technique with O_{000} nulls is in many aspects identical to the approach presented in [GMCLIB_SvmStd](#). However, a distinct difference lies in the definition of the variables t_1 , t_2 , and t_3 that represent switching duty-cycle ratios of the respective phases:

$$\begin{aligned}t_1 &= 0 \\t_2 &= t_1 + t_{_1} \\t_3 &= t_2 + t_{_2}\end{aligned}$$

Equation 47

where T is the switching period, and $t_{_1}$ and $t_{_2}$ are the duty-cycle ratios of the basic space vectors that are defined for the respective sector in [Table 2-10](#).

The generally used center-aligned PWM is discussed briefly in the following sections. Generating the center-aligned PWM pattern is accomplished practically by comparing the threshold levels `pwm_a`, `pwm_b`, and `pwm_c` with the free-running up/down counter. The timer counts up to 1 (0x7FFF) and then down to 0 (0x0000). It is supposed that when a threshold level is larger than the timer value, the respective PWM output is active. Otherwise it is inactive (see [Figure 2-17](#)).

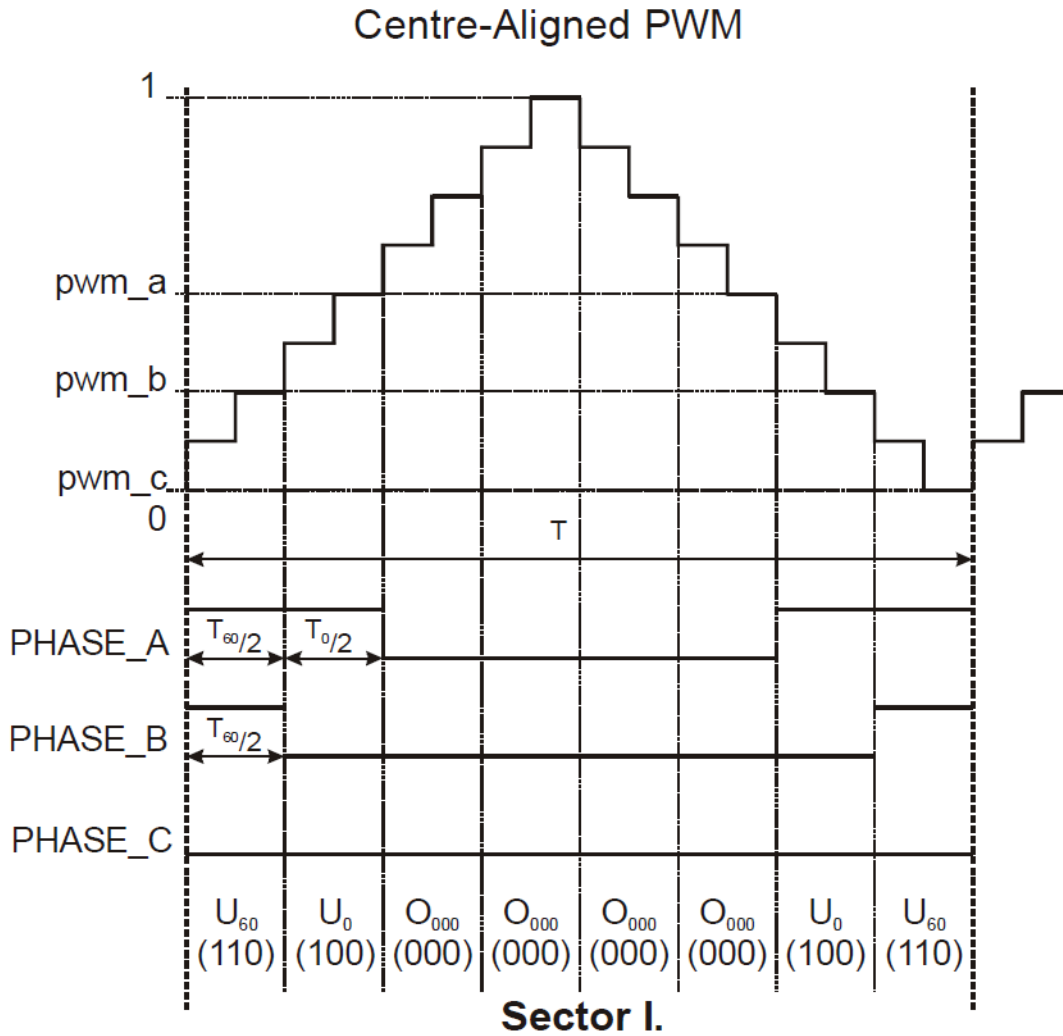

Figure 2-17. Space vector modulation technique with O₀₀₀ nulls — center-aligned PWM

Figure [Figure 2-17](#) shows calculated waveforms of the duty cycle ratios using space vector modulation with O₀₀₀ nulls.

For an accurate calculation of the duty-cycle ratios, direct- α , and quadrature- β components of the stator reference voltage vector, consider that the duty cycle cannot be higher than one (100 %); in other words, the assumption $\sqrt{\alpha^2 + \beta^2} \leq 1$ must be met.

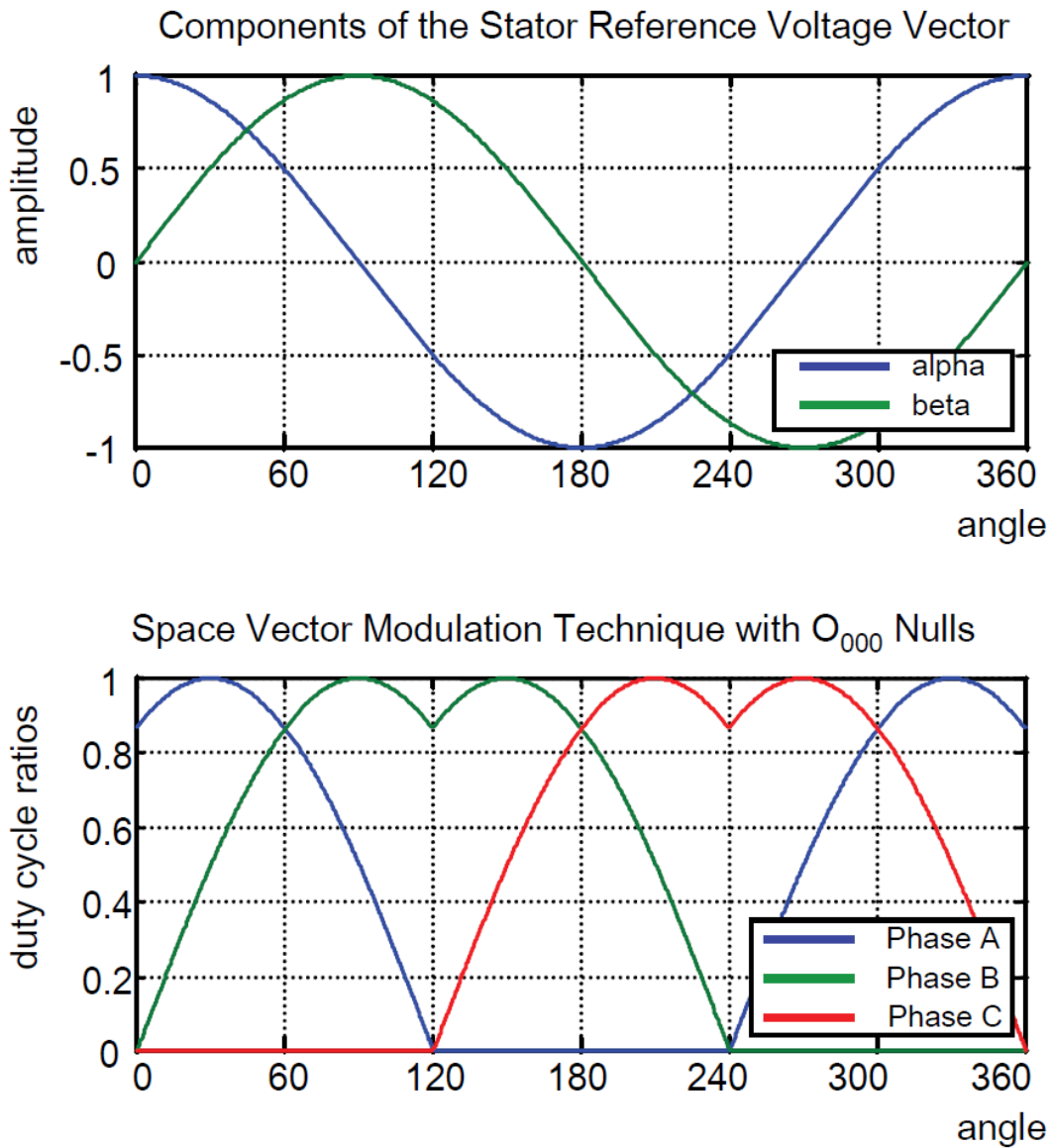

Figure 2-18. Space vector modulation technique with O₀₀₀ nulls

2.10.1 Available versions

This function is available in the following versions:

- Fractional output - the output is the fractional portion of the result; the result is within the range <0 ; 1). The result may saturate.

The available versions of the [GMCLIB_SvmU0n](#) function are shown in the following table:

Table 2-15. Function versions

Function name	Input type	Output type	Result type
GMCLIB_SvmU0n_F16	GMCLIB_2COOR_ALBE_T_F16 *	GMCLIB_3COOR_T_F16 *	uint16_t
	General sinusoidal space vector modulation with a 16-bit fractional stationary (α - β) input, and a 16-bit fractional three-phase output. The result type is a 16-bit unsigned integer, which indicates the actual SVM sector. The input is within the range $\langle -1 ; 1 \rangle$; the output duty cycle is within the range $\langle 0 ; 1 \rangle$. The output sector is an integer value within the range $\langle 1 ; 6 \rangle$.		

2.10.2 Declaration

The available [GMCLIB_SvmU0n](#) functions have the following declarations:

```
uint16_t GMCLIB_SvmU0n_F16(const GMCLIB_2COOR_ALBE_T_F16 *psIn, GMCLIB_3COOR_T_F16 *psOut)
```

2.10.3 Function use

The use of the [GMCLIB_SvmU0n](#) function is shown in the following example:

```
#include "gmclib.h"

static uint16_t u16Sector;
static GMCLIB_2COOR_ALBE_T_F16 sAlphaBeta;
static GMCLIB_3COOR_T_F16 sAbc;

void Isr(void);

void main(void)
{
    /* Alpha, Beta structure initialization */
    sAlphaBeta.f16Alpha = FRAC16(0.0);
    sAlphaBeta.f16Beta = FRAC16(0.0);
}

/* Periodical function or interrupt */
void Isr(void)
{
    /* SVM calculation */
    u16Sector = GMCLIB_SvmU0n_F16(&sAlphaBeta, &sAbc);
}
```

2.11 GMCLIB_SvmU7n

The [GMCLIB_SvmU7n](#) function calculates the appropriate duty-cycle ratios, which are needed for generation of the given stator-reference voltage vector, using the general sinusoidal modulation technique.

The [GMCLIB_SvmU7n](#) function for calculating the duty-cycle ratios is widely used in modern electric drives. This function calculates the appropriate duty-cycle ratios, which are needed for generating the given stator reference voltage vector using a special space vector modulation technique called space vector modulation with O_{111} nulls, where only one type of null vector O_{111} is used (all top switches are turned on in the inverter).

The derivation approach of the space vector modulation technique with O_{111} nulls is identical (in many aspects) to the approach presented in [GMCLIB_SvmStd](#). However, a distinct difference lies in the definition of variables t_1 , t_2 , and t_3 that represent switching duty-cycle ratios of the respective phases:

$$\begin{aligned}t_1 &= T - t_{-1} - t_{-2} \\t_2 &= t_1 + t_{-1} \\t_3 &= t_2 + t_{-2}\end{aligned}$$

Equation 48

where T is the switching period, and t_{-1} and t_{-2} are the duty-cycle ratios of the basic space vectors defined for the respective sector in [Table 2-10](#).

The generally-used center-aligned PWM is discussed briefly in the following sections. Generating the center-aligned PWM pattern is accomplished by comparing threshold levels `pwm_a`, `pwm_b`, and `pwm_c` with the free-running up/down counter. The timer counts up to 1 (0x7FFF) and then down to 0 (0x0000). It is supposed that when a threshold level is larger than the timer value, the respective PWM output is active. Otherwise, it is inactive (see [Figure 2-19](#)).

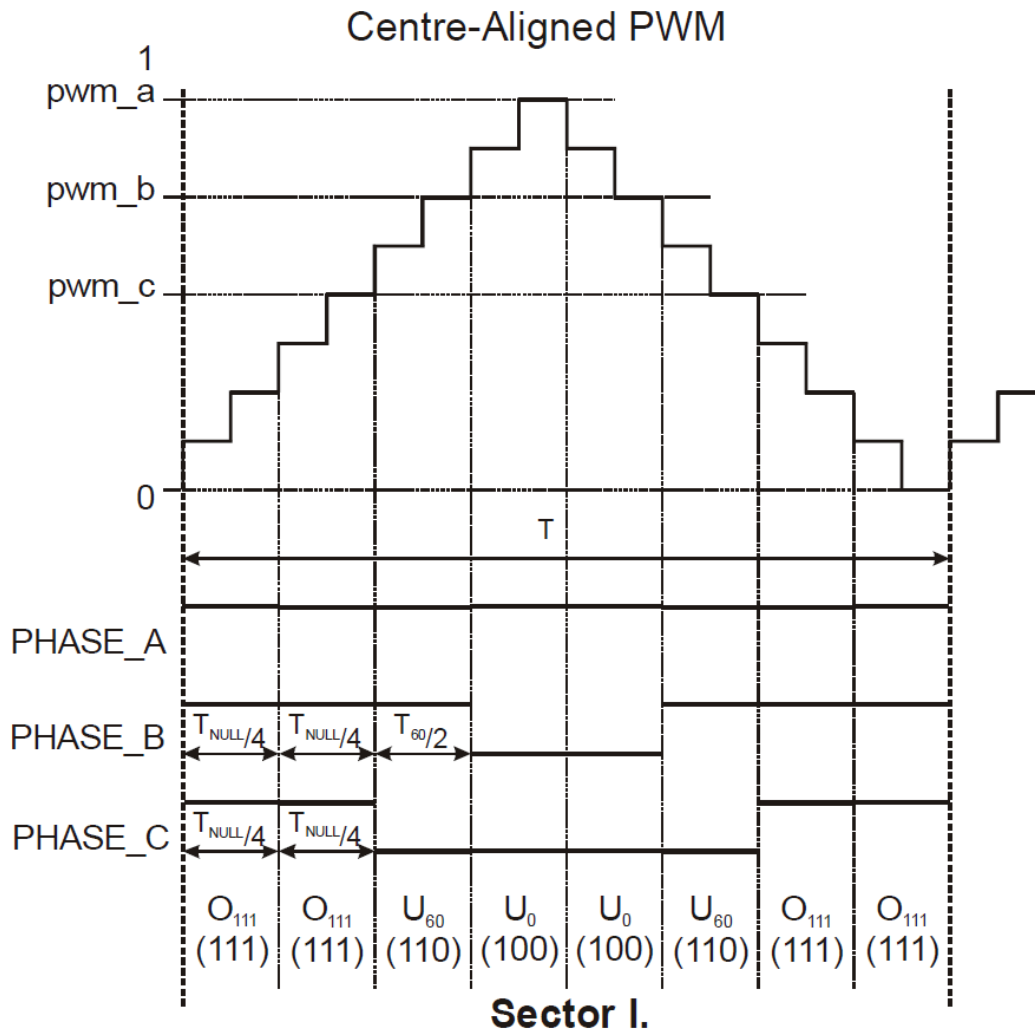

Figure 2-19. Space vector modulation technique with O_{111} nulls — center-aligned PWM

Figure [Figure 2-19](#) shows calculated waveforms of the duty-cycle ratios using Space Vector Modulation with O_{111} nulls.

For an accurate calculation of the duty-cycle ratios, direct- α , and quadrature- β components of the stator reference voltage vector, it must be considered that the duty cycle cannot be higher than one (100 %); in other words, the assumption $\sqrt{\alpha^2 + \beta^2} \leq 1$ must be met.

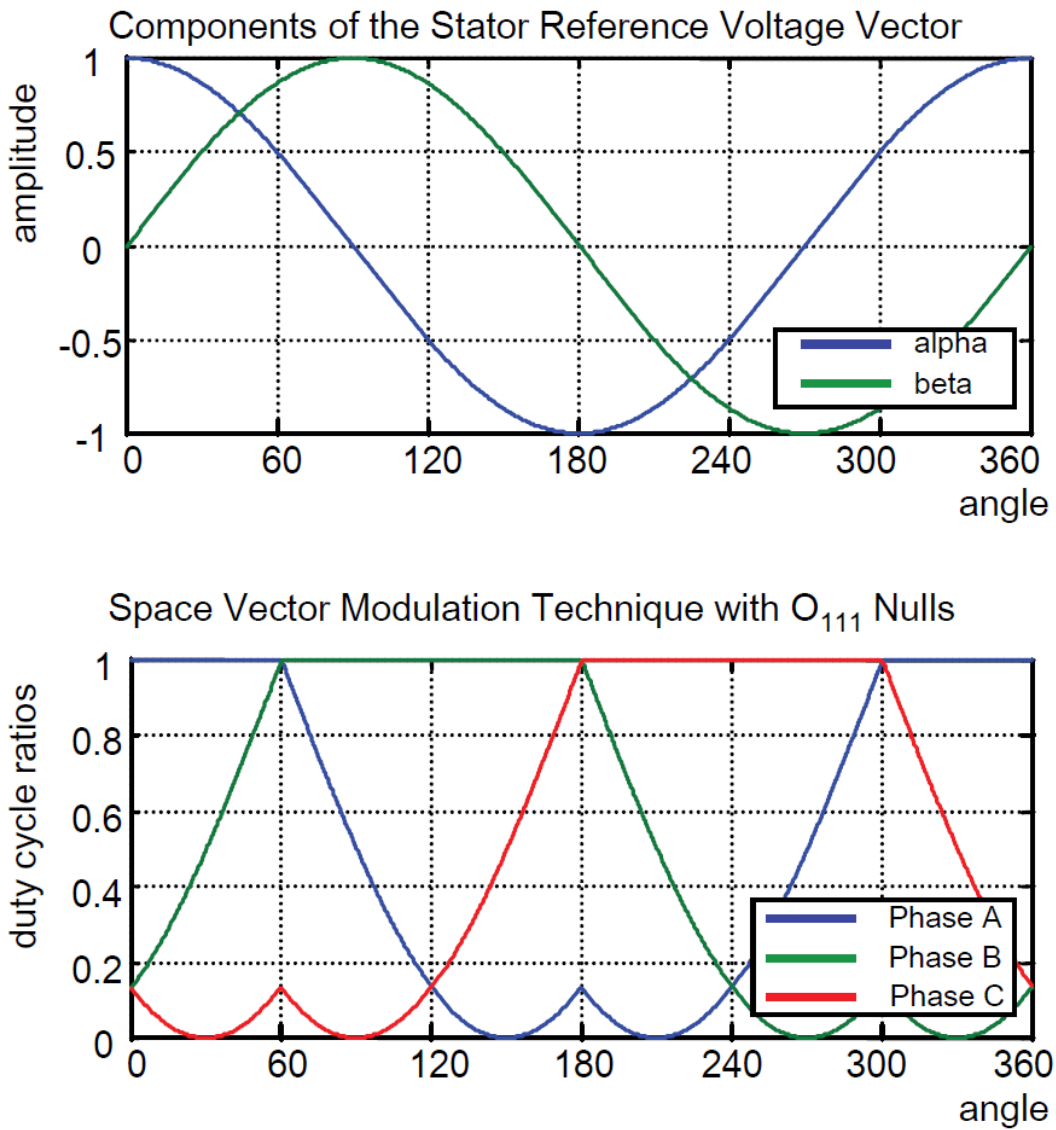

Figure 2-20. Space vector modulation technique with O₁₁₁ nulls

2.11.1 Available versions

This function is available in the following versions:

- Fractional output - the output is the fractional portion of the result; the result is within the range <0 ; 1). The result may saturate.

The available versions of the [GMCLIB_SvmU7n](#) function are shown in the following table:

Table 2-16. Function versions

Function name	Input type	Output type	Result type
GMCLIB_SvmU7n_F16	GMCLIB_2COOR_ALBE_T_F16 *	GMCLIB_3COOR_T_F16 *	uint16_t
	General sinusoidal space vector modulation with a 16-bit fractional stationary (α - β) input and a 16-bit fractional three-phase output. The result type is a 16-bit unsigned integer, which indicates the actual SVM sector. The input is within the range $\langle -1 ; 1 \rangle$; the output duty cycle is within the range $\langle 0 ; 1 \rangle$. The output sector is an integer value within the range $\langle 1 ; 6 \rangle$.		

2.11.2 Declaration

The available [GMCLIB_SvmU7n](#) functions have the following declarations:

```
uint16_t GMCLIB_SvmU7n_F16(const GMCLIB_2COOR_ALBE_T_F16 *psIn, GMCLIB_3COOR_T_F16 *psOut)
```

2.11.3 Function use

The use of the [GMCLIB_SvmU7n](#) function is shown in the following example:

```
#include "gmclib.h"

static uint16_t u16Sector;
static GMCLIB_2COOR_ALBE_T_F16 sAlphaBeta;
static GMCLIB_3COOR_T_F16 sAbc;

void Isr(void);

void main(void)
{
    /* Alpha, Beta structure initialization */
    sAlphaBeta.f16Alpha = FRAC16(0.0);
    sAlphaBeta.f16Beta = FRAC16(0.0);
}

/* Periodical function or interrupt */
void Isr(void)
{
    /* SVM calculation */
    u16Sector = GMCLIB_SvmU7n_F16(&sAlphaBeta, &sAbc);
}
```

2.12 GMCLIB_SvmDpwm

The [GMCLIB_SvmDpwm](#) function calculates the appropriate duty-cycle ratios needed for the generation of the given stator-reference voltage vector using the general non-sinusoidal modulation technique. The [GMCLIB_SvmDpwm](#) function is a subset of the [GMCLIB_SvmExDpwm](#) function and includes a power factor angle input. Both functions are identical if $\varphi = 0$.

The [GMCLIB_SvmDpwm](#) function belongs to the discontinuous PWM modulation techniques for 3-phase voltage inverters. The advantages of the discontinuous PWM technique are lower switching losses, but, on the other hand, it can cause higher harmonic distortion at low modulation indexes. The current sensing at low modulation indexes is more complicated and less precise when compared with the symmetrical modulation techniques like [GMCLIB_SvmStd](#). Therefore, the discontinuous and continuous SVM are usually combined together.

Finding the sector in which the reference stator voltage vector U_S resides is similar to [GMCLIB_SvmStd](#). This is achieved by converting the direct- α and quadrature- β components of the reference stator voltage vector U_S into the balanced 3-phase quantities u_{ref1} , u_{ref2} , and u_{ref3} using the modified Inverse Clarke transformation:

$$\begin{aligned}
 u_{ref1} &= u_\beta \\
 u_{ref2} &= \frac{\sqrt{3}u_\alpha - u_\beta}{2} \\
 u_{ref3} &= \frac{-\sqrt{3}u_\alpha - u_\beta}{2}
 \end{aligned}$$

Equation 49

The sector calculation is based on comparing the 3-phase reference voltages u_{ref1} , u_{ref2} , and u_{ref3} with zero. This computation is described by the following figure:

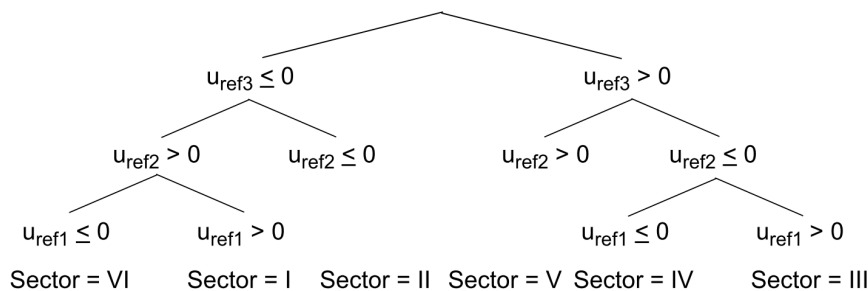

Figure 2-21. Identification of the sector number

The knowledge of the sector is necessary for the current sensing especially when shunt resistors are used. The [GMCLIB_SvmDpwm](#) function does not require the sector directly, but it requires the portion identification explained in the following. The Inverse Clarke transformation converts the u_α , u_β voltage components of the reference stator

voltage vector U_S to 3-phase voltage components u_a , u_b , and u_c . The portion identification selects the portion from the u_a , u_b , and u_c voltages, based on the following conditions.

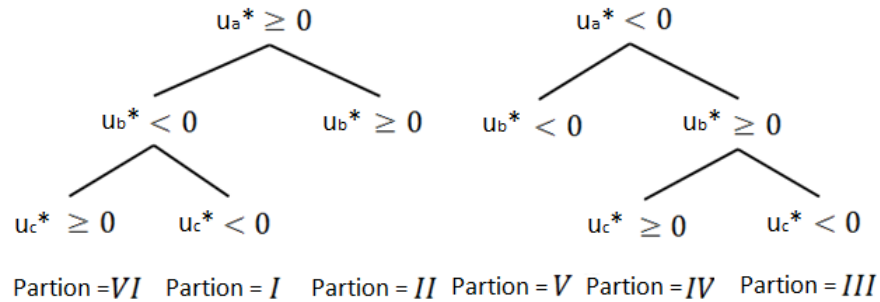

Figure 2-22. Identification of the portion number

Finally, the corresponding duty cycle is selected according to the portion from the column of the following table.

Table 2-17. Duty cycle calculation from portions

Portions	I	II	III	IV	V	VI
Voltage boundaries	U_{330}, U_{30}	U_{30}, U_{90}	U_{90}, U_{150}	U_{150}, U_{210}	U_{210}, U_{270}	U_{270}, U_{330}
pwm_a	1	$0 - u_{ref3}$	$1 + u_{ref2}$	0	$1 - u_{ref3}$	$0 + u_{ref2}$
pwm_b	$1 - u_{ref2}$	$0 + u_{ref1} = u_{\beta}$	1	$0 - u_{ref2}$	$1 + u_{ref1} = 1 + u_{\beta}$	0
pwm_c	$1 + u_{ref3}$	0	$1 - u_{ref1} = 1 - u_{\beta}$	$0 + u_{ref3}$	1	$0 - u_{ref1} = 0 - u_{\beta}$

2.12.1 Available versions

This function is available in the following versions:

- Fractional output - the output is the fractional portion of the result; the result is within the range $<0 ; 1)$. The result may saturate.

The available versions of the [GMCLIB_SvmDpwm](#) function are shown in the following table:

Table 2-18. Function versions

Function name	Input type	Output type	Result type
GMCLIB_SvmDpwm_F16	GMCLIB_2COOR_ALBE_T_F16 *	GMCLIB_3COOR_T_F16 *	uint16_t
	Standard discontinuous PWM with a 16-bit fractional stationary (α - β) input, and a 16-bit fractional 3-phase output. The result type is a 16-bit unsigned integer, which indicates the actual SVM sector. The input is within the range $<-1 ; 1)$; the output duty cycle is within the range $<0 ; 1)$. The output sector is an integer value within the range $<1 ; 6>$.		

2.12.2 Declaration

The available [GMCLIB_SvmDpwm](#) functions have the following declarations:

```
uint16_t GMCLIB_SvmDpwm_F16(const GMCLIB_2COOR_ALBE_T_F16 *psIn, GMCLIB_3COOR_T_F16 *psOut)
```

2.12.3 Function use

The use of the [GMCLIB_SvmDpwm](#) function is shown in the following example:

```
#include "gmclib.h"

static uint16_t u16Sector;
static GMCLIB_2COOR_ALBE_T_F16 sAlphaBeta;
static GMCLIB_3COOR_T_F16 sAbc;

void Isr(void);

void main(void)
{
    /* Alpha, Beta structure initialization */
    sAlphaBeta.f16Alpha = FRAC16(0.0);
    sAlphaBeta.f16Beta = FRAC16(0.0);

    /* Periodical function or interrupt */
}

void Isr(void)
{
    /* Standard Discontinues PWM SVM calculation */
    u16Sector = GMCLIB_SvmGenDpwm_F16(&sAlphaBeta, &sAbc);
}
```

2.13 GMCLIB_SvmExDpwm

The [GMCLIB_SvmExDpwm](#) function calculates the appropriate duty-cycle ratios needed for the generation of the given stator-reference voltage vector using the general non-sinusoidal modulation technique. The [GMCLIB_SvmExDpwm](#) function is a superset of the [GMCLIB_SvmDpwm](#) function without the power factor angle input.

The [GMCLIB_SvmExDpwm](#) function belongs to the discontinuous PWM modulation techniques for a 3-phase voltage inverter. The advantages of the discontinuous PWM technique are lower switching losses, but, on the other hand, it can cause higher harmonic distortion at low modulation indexes. The current sensing at low modulation indexes is

more complicated and less precise when compared to the symmetrical modulation techniques like [GMCLIB_SvmStd](#). Therefore, the discontinuous and continuous SVM are usually combined together.

Finding the sector in which the reference stator voltage vector U_S resides is similar to [GMCLIB_SvmStd](#). This is achieved by converting the direct- α and quadrature- β components of the reference stator voltage vector U_S into the balanced 3-phase quantities u_{ref1} , u_{ref2} , and u_{ref3} using the modified Inverse Clarke transformation:

$$\begin{aligned} u_{ref1} &= u_\beta \\ u_{ref2} &= \frac{\sqrt{3} \cdot u_\alpha - u_\beta}{2} \\ u_{ref3} &= \frac{-\sqrt{3} \cdot u_\alpha - u_\beta}{2} \end{aligned}$$

Equation 50

The sector calculation is based on comparing the 3-phase reference voltages u_{ref1} , u_{ref2} , and u_{ref3} with zero. This computation is described by the following figure:

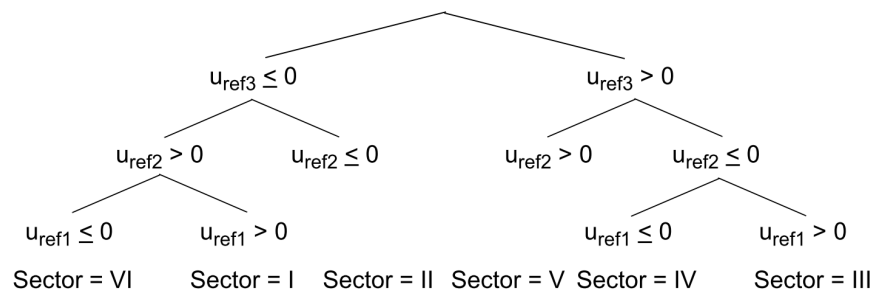

Figure 2-23. Identification of the sector number

The knowledge of the sector is necessary for the current sensing especially when shunt resistors are used. The [GMCLIB_SvmExDpwm](#) function does not require the sector directly, but it requires the portion identification explained in following text. The Park transformation uses the phase shift of the generated phase voltages and currents - φ angle to rotate the reference stator voltage vector U_S to U_S^* with the u_α^* , u_β^* components. The inverse Clarke transformation converts the u_α^* , u_β^* voltage components to 3-phase voltage components u_a^* , u_b^* , and u_c^* . The portion identification selects the portion from the u_a^* , u_b^* , and u_c^* voltages based on the following conditions.

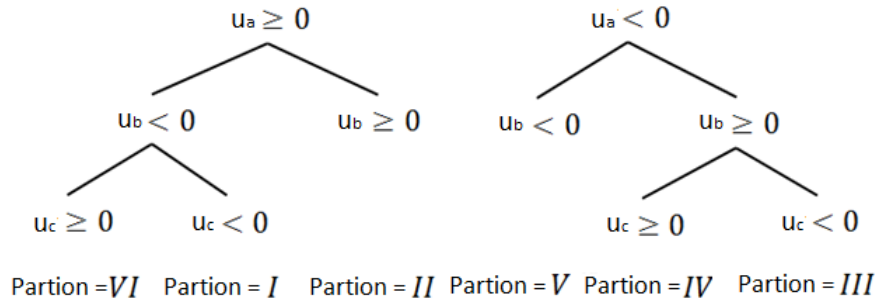

Figure 2-24. Identification of the portion number

Finally, the corresponding duty cycle is selected according to the portion from the column of the following table.

Table 2-19. Duty cycle calculation from portions

Portions	I	II	III	IV	V	VI
Voltage boundaries	U_{330}, U_{30}	U_{30}, U_{90}	U_{90}, U_{150}	U_{150}, U_{210}	U_{210}, U_{270}	U_{270}, U_{330}
pwm_a	1	$0 - u_{ref3}$	$1 + u_{ref2}$	0	$1 - u_{ref3}$	$0 + u_{ref2}$
pwm_b	$1 - u_{ref2}$	$0 + u_{ref1} = u_{\beta}$	1	$0 - u_{ref2}$	$1 + u_{ref1} = 1 + u_{\beta}$	0
pwm_c	$1 + u_{ref3}$	0	$1 - u_{ref1} = 1 - u_{\beta}$	$0 + u_{ref3}$	1	$0 - u_{ref1} = 0 - u_{\beta}$

2.13.1 Available versions

This function is available in the following versions:

- Fractional output - the output is the fractional portion of the result; the result is within the range $<0 ; 1$). The result may saturate.

The available versions of the [GMCLIB_SvmExDpwm](#) function are shown in the following table:

Table 2-20. Function versions

Function name	Input type	Output type	Result type
GMCLIB_SvmExDpwm_F16	GMCLIB_2COOR_ALBE_T_F16 *	GMCLIB_2COOR_DQ_T_F16 *	uint16_t
	GMCLIB_2COOR_SINCOS_T_F16 *		
Extended discontinuous PWM with a 16-bit fractional stationary (α - β) input, the second input using a 16-bit fractional ($\sin(\varphi) / \cos(\varphi)$) structure of φ angle ($-1/6 ; 1/6$) in fraction corresponding ($-\pi/6 ; \pi/6$) in radians - angle of the power factor, it is a phase shift of the generated phase voltages and currents and a 16-bit fractional 3-phase output. The result type is a 16-bit unsigned integer which indicates the actual SVM sector. The input is within the range $<-1 ; 1$); the output duty cycle is within the range $<0 ; 1$). The output sector is an integer value within the range $<1 ; 6>$.			

2.13.2 Declaration

The available `GMCLIB_SvmExDpwm` functions have the following declarations:

```
uint16_t GMCLIB_SvmExDpwm_F16(const GMCLIB_2COOR_ALBE_T_F16 *psIn, const
GMCLIB_2COOR_SINCOS_T_F16 *psAngle, GMCLIB_3COOR_T_F16 *psOut)
```

2.13.3 Function use

The use of the `GMCLIB_SvmExDpwm` function is shown in the following example:

```
#include "gmclib.h"

static uint16_t ul6Sector;
static GMCLIB_2COOR_ALBE_T_F16 sAlphaBeta;
static GMCLIB_2COOR_SINCOS_T_F16 sAlphaBeta;
static GMCLIB_3COOR_T_F16 sAbc;

void Isr(void);

void main(void)
{
    /* Alpha, Beta structure initialization */
    sAlphaBeta.f16Alpha = FRAC16(0.0);
    sAlphaBeta.f16Beta = FRAC16(0.0);

    /* Power factor angle structure initialization */
    sAngle.f16Cos = FRAC16(1.0);
    sAngle.f16Sin = FRAC16(0.0);
}

/* Periodical function or interrupt */
void Isr(void)
{
    /* Extended Discontinues PWM calculation */
    ul6Sector = GMCLIB_SvmExDpwm_F16(&sAlphaBeta, &sAngle, &sAbc);
}
```

Appendix A

Library types

A.1 bool_t

The `bool_t` type is a logical 16-bit type. It is able to store the boolean variables with two states: TRUE (1) or FALSE (0). Its definition is as follows:

```
typedef unsigned short bool_t;
```

The following figure shows the way in which the data is stored by this type:

Table A-1. Data storage

	15	14	13	12	11	10	9	8	7	6	5	4	3	2	1	0	
Value	Unused															Logical	
TRUE	0	0	0	0	0	0	0	0	0	0	0	0	0	0	0	0	1
	0				0				0				1				
FALSE	0	0	0	0	0	0	0	0	0	0	0	0	0	0	0	0	0
	0				0				0				0				

To store a logical value as `bool_t`, use the `FALSE` or `TRUE` macros.

A.2 uint8_t

The `uint8_t` type is an unsigned 8-bit integer type. It is able to store the variables within the range <0 ; 255>. Its definition is as follows:

```
typedef unsigned char uint8_t;
```

The following figure shows the way in which the data is stored by this type:

Table A-2. Data storage

	7	6	5	4	3	2	1	0
Value	Integer							
255	1	1	1	1	1	1	1	1
	F				F			
11	0	0	0	0	1	0	1	1
	0				B			
124	0	1	1	1	1	1	0	0
	7				C			
159	1	0	0	1	1	1	1	1
	9				F			

A.3 uint16_t

The `uint16_t` type is an unsigned 16-bit integer type. It is able to store the variables within the range $\langle 0 ; 65535 \rangle$. Its definition is as follows:

```
typedef unsigned short uint16_t;
```

The following figure shows the way in which the data is stored by this type:

Table A-3. Data storage

	15	14	13	12	11	10	9	8	7	6	5	4	3	2	1	0
Value	Integer															
65535	1	1	1	1	1	1	1	1	1	1	1	1	1	1	1	1
	F				F				F				F			
5	0	0	0	0	0	0	0	0	0	0	0	0	0	1	0	1
	0				0				0				5			
15518	0	0	1	1	1	1	0	0	1	0	0	1	1	1	1	0
	3				C				9				E			
40768	1	0	0	1	1	1	1	1	0	1	0	0	0	0	0	0
	9				F				4				0			

A.4 uint32_t

The `uint32_t` type is an unsigned 32-bit integer type. It is able to store the variables within the range $\langle 0 ; 4294967295 \rangle$. Its definition is as follows:

```
typedef unsigned long uint32_t;
```

The following figure shows the way in which the data is stored by this type:

Table A-4. Data storage

Value	31	24 23		16 15		8 7		0
	Integer							
4294967295	F	F	F	F	F	F	F	F
2147483648	8	0	0	0	0	0	0	0
55977296	0	3	5	6	2	5	5	0
3451051828	C	D	B	2	D	F	3	4

A.5 int8_t

The `int8_t` type is a signed 8-bit integer type. It is able to store the variables within the range $\langle -128 ; 127 \rangle$. Its definition is as follows:

```
typedef char int8_t;
```

The following figure shows the way in which the data is stored by this type:

Table A-5. Data storage

Value	7	6	5	4	3	2	1	0
	Sign	Integer						
127	0	1	1	1	1	1	1	1
	7				F			
-128	1	0	0	0	0	0	0	0
	8				0			
60	0	0	1	1	1	1	0	0
	3				C			
-97	1	0	0	1	1	1	1	1
	9				F			

A.6 int16_t

The `int16_t` type is a signed 16-bit integer type. It is able to store the variables within the range $\langle -32768 ; 32767 \rangle$. Its definition is as follows:

```
typedef short int16_t;
```

The following figure shows the way in which the data is stored by this type:

Table A-6. Data storage

	15	14	13	12	11	10	9	8	7	6	5	4	3	2	1	0	
Value	Sign	Integer															
32767	0	1	1	1	1	1	1	1	1	1	1	1	1	1	1	1	
		7				F				F				F			
-32768	1	0	0	0	0	0	0	0	0	0	0	0	0	0	0	0	
		8				0				0				0			
15518	0	0	1	1	1	1	0	0	1	0	0	1	1	1	1	0	
		3			C				9				E				
-24768	1	0	0	1	1	1	1	1	0	1	0	0	0	0	0	0	
		9				F				4				0			

A.7 int32_t

The `int32_t` type is a signed 32-bit integer type. It is able to store the variables within the range $\langle -2147483648 ; 2147483647 \rangle$. Its definition is as follows:

```
typedef long int32_t;
```

The following figure shows the way in which the data is stored by this type:

Table A-7. Data storage

	31	24	23	16	15	8	7	0																				
Value	S	Integer																										
2147483647	7	F	F	F	F	F	F	F																				
-2147483648	8	0	0	0	0	0	0	0																				
55977296	0	3	5	6	2	5	5	0																				
-843915468	C	D	B	2	D	F	3	4																				

A.8 frac8_t

The `frac8_t` type is a signed 8-bit fractional type. It is able to store the variables within the range $<-1 ; 1$). Its definition is as follows:

```
typedef char frac8_t;
```

The following figure shows the way in which the data is stored by this type:

Table A-8. Data storage

	7	6	5	4	3	2	1	0
Value	Sign	Fractional						
0.99219	0	1	1	1	1	1	1	1
	7				F			
-1.0	1	0	0	0	0	0	0	0
	8				0			
0.46875	0	0	1	1	1	1	0	0
	3				C			
-0.75781	1	0	0	1	1	1	1	1
	9				F			

To store a real number as `frac8_t`, use the `FRAC8` macro.

A.9 frac16_t

The `frac16_t` type is a signed 16-bit fractional type. It is able to store the variables within the range $<-1 ; 1$). Its definition is as follows:

```
typedef short frac16_t;
```

The following figure shows the way in which the data is stored by this type:

Table A-9. Data storage

	15	14	13	12	11	10	9	8	7	6	5	4	3	2	1	0
Value	Sign	Fractional														
0.99997	0	1	1	1	1	1	1	1	1	1	1	1	1	1	1	1
	7				F				F				F			
-1.0	1	0	0	0	0	0	0	0	0	0	0	0	0	0	0	0

Table continues on the next page...

Table A-9. Data storage (continued)

0.47357	8				0				0				0			
	0	0	1	1	1	1	0	0	1	0	0	1	1	1	1	0
-0.75586	3				C				9				E			
	1	0	0	1	1	1	1	1	0	1	0	0	0	0	0	0
	9				F				4				0			

To store a real number as `frac16_t`, use the `FRAC16` macro.

A.10 frac32_t

The `frac32_t` type is a signed 32-bit fractional type. It is able to store the variables within the range $<-1 ; 1$). Its definition is as follows:

```
typedef long frac32_t;
```

The following figure shows the way in which the data is stored by this type:

Table A-10. Data storage

Value	31	24 23		16 15		8 7		0
	S	Fractional						
0.9999999995	7	F	F	F	F	F	F	F
-1.0	8	0	0	0	0	0	0	0
0.02606645970	0	3	5	6	2	5	5	0
-0.3929787632	C	D	B	2	D	F	3	4

To store a real number as `frac32_t`, use the `FRAC32` macro.

A.11 acc16_t

The `acc16_t` type is a signed 16-bit fractional type. It is able to store the variables within the range $<-256 ; 256$). Its definition is as follows:

```
typedef short acc16_t;
```

The following figure shows the way in which the data is stored by this type:

Table A-11. Data storage

	15	14	13	12	11	10	9	8	7	6	5	4	3	2	1	0
Value	Sign	Integer							Fractional							
255.9921875	0	1	1	1	1	1	1	1	1	1	1	1	1	1	1	1
	7			F				F				F				
-256.0	1	0	0	0	0	0	0	0	0	0	0	0	0	0	0	0
	8			0				0				0				
1.0	0	0	0	0	0	0	0	0	1	0	0	0	0	0	0	0
	0			0				8				0				
-1.0	1	1	1	1	1	1	1	1	1	0	0	0	0	0	0	0
	F			F				8				0				
13.7890625	0	0	0	0	0	1	1	0	1	1	1	0	0	1	0	1
	0			6				E				5				
-89.71875	1	1	0	1	0	0	1	1	0	0	1	0	0	1	0	0
	D			3				2				4				

To store a real number as `acc16_t`, use the `ACC16` macro.

A.12 `acc32_t`

The `acc32_t` type is a signed 32-bit accumulator type. It is able to store the variables within the range $<-65536 ; 65536$). Its definition is as follows:

```
typedef long acc32_t;
```

The following figure shows the way in which the data is stored by this type:

Table A-12. Data storage

	31	24	23	16	15	8	7	0	
Value	S	Integer				Fractional			
65535.999969	7	F	F	F	F	F	F	F	
-65536.0	8	0	0	0	0	0	0	0	
1.0	0	0	0	0	8	0	0	0	
-1.0	F	F	F	F	8	0	0	0	
23.789734	0	0	0	B	E	5	1	6	
-1171.306793	F	D	B	6	5	8	B	C	

To store a real number as `acc32_t`, use the `ACC32` macro.

A.13 GMCLIB_3COOR_T_F16

The [GMCLIB_3COOR_T_F16](#) structure type corresponds to the three-phase stationary coordinate system, based on the A, B, and C components. Each member is of the [frac16_t](#) data type. The structure definition is as follows:

```
typedef struct
{
    frac16_t f16A;
    frac16_t f16B;
    frac16_t f16C;
} GMCLIB_3COOR_T_F16;
```

The structure description is as follows:

Table A-13. GMCLIB_3COOR_T_F16 members description

Type	Name	Description
frac16_t	f16A	A component; 16-bit fractional type
frac16_t	f16B	B component; 16-bit fractional type
frac16_t	f16C	C component; 16-bit fractional type

A.14 GMCLIB_2COOR_AB_T_F16

The [GMCLIB_2COOR_AB_T_F16](#) structure type corresponds to the general two-phase stationary coordinate system, based on the A and B orthogonal components. Each member is of the [frac16_t](#) data type. The structure definition is as follows:

```
typedef struct
{
    frac16_t f16A;
    frac16_t f16B;
} GMCLIB_2COOR_AB_T_F16;
```

The structure description is as follows:

Table A-14. GMCLIB_2COOR_AB_T_F16 members description

Type	Name	Description
frac16_t	f16A	A-component; 16-bit fractional type
frac16_t	f16B	B-component; 16-bit fractional type

A.15 GMCLIB_2COOR_AB_T_F32

The [GMCLIB_2COOR_AB_T_F32](#) structure type corresponds to the general two-phase stationary coordinate system, based on the A and B orthogonal components. Each member is of the [frac32_t](#) data type. The structure definition is as follows:

```
typedef struct
{
    frac32_t f32Alpha;
    frac32_t f32Beta;
} GMCLIB_2COOR_AB_T_F32;
```

The structure description is as follows:

Table A-15. GMCLIB_2COOR_AB_T_F32 members description

Type	Name	Description
frac32_t	f32A	A component; 32-bit fractional type
frac32_t	f32B	B component; 32-bit fractional type

A.16 GMCLIB_2COOR_ALBE_T_F16

The [GMCLIB_2COOR_ALBE_T_F16](#) structure type corresponds to the two-phase stationary coordinate system, based on the Alpha and Beta orthogonal components. Each member is of the [frac16_t](#) data type. The structure definition is as follows:

```
typedef struct
{
    frac16_t f16Alpha;
    frac16_t f16Beta;
} GMCLIB_2COOR_ALBE_T_F16;
```

The structure description is as follows:

Table A-16. GMCLIB_2COOR_ALBE_T_F16 members description

Type	Name	Description
frac16_t	f16Apha	α -component; 16-bit fractional type
frac16_t	f16Beta	β -component; 16-bit fractional type

A.17 GMCLIB_2COOR_DQ_T_F16

The [GMCLIB_2COOR_DQ_T_F16](#) structure type corresponds to the two-phase rotating coordinate system, based on the D and Q orthogonal components. Each member is of the [frac16_t](#) data type. The structure definition is as follows:

```
typedef struct
{
    frac16_t f16D;
    frac16_t f16Q;
} GMCLIB_2COOR_DQ_T_F16;
```

The structure description is as follows:

Table A-17. GMCLIB_2COOR_DQ_T_F16 members description

Type	Name	Description
frac16_t	f16D	D-component; 16-bit fractional type
frac16_t	f16Q	Q-component; 16-bit fractional type

A.18 GMCLIB_2COOR_DQ_T_F32

The [GMCLIB_2COOR_DQ_T_F32](#) structure type corresponds to the two-phase rotating coordinate system, based on the D and Q orthogonal components. Each member is of the [frac32_t](#) data type. The structure definition is as follows:

```
typedef struct
{
    frac32_t f32D;
    frac32_t f32Q;
} GMCLIB_2COOR_DQ_T_F32;
```

The structure description is as follows:

Table A-18. GMCLIB_2COOR_DQ_T_F32 members description

Type	Name	Description
frac32_t	f32D	D-component; 32-bit fractional type
frac32_t	f32Q	Q-component; 32-bit fractional type

A.19 GMCLIB_2COOR_SINCOS_T_F16

The [GMCLIB_2COOR_SINCOS_T_F16](#) structure type corresponds to the two-phase coordinate system, based on the Sin and Cos components of a certain angle. Each member is of the [frac16_t](#) data type. The structure definition is as follows:

```
typedef struct
{
    frac16_t f16Sin;
    frac16_t f16Cos;
} GMCLIB_2COOR_SINCOS_T_F16;
```

The structure description is as follows:

Table A-19. GMCLIB_2COOR_SINCOS_T_F16 members description

Type	Name	Description
frac16_t	f16Sin	Sin component; 16-bit fractional type
frac16_t	f16Cos	Cos component; 16-bit fractional type

A.20 FALSE

The **FALSE** macro serves to write a correct value standing for the logical FALSE value of the **bool_t** type. Its definition is as follows:

```
#define FALSE    ((bool_t)0)

#include "mlib.h"

static bool_t bVal;

void main(void)
{
    bVal = FALSE;           /* bVal = FALSE */
}
```

A.21 TRUE

The **TRUE** macro serves to write a correct value standing for the logical TRUE value of the **bool_t** type. Its definition is as follows:

```
#define TRUE     ((bool_t)1)

#include "mlib.h"

static bool_t bVal;

void main(void)
{
    bVal = TRUE;           /* bVal = TRUE */
}
```

A.22 FRAC8

The **FRAC8** macro serves to convert a real number to the `frac8_t` type. Its definition is as follows:

```
#define FRAC8(x) ((frac8_t)((x) < 0.9921875 ? ((x) >= -1 ? (x)*0x80 : 0x80) : 0x7F))
```

The input is multiplied by 128 ($=2^7$). The output is limited to the range $\langle 0x80 ; 0x7F \rangle$, which corresponds to $\langle -1.0 ; 1.0 \cdot 2^{-7} \rangle$.

```
#include "mlib.h"
static frac8_t f8Val;
void main(void)
{
    f8Val = FRAC8(0.187);          /* f8Val = 0.187 */
}
```

A.23 FRAC16

The **FRAC16** macro serves to convert a real number to the `frac16_t` type. Its definition is as follows:

```
#define FRAC16(x) ((frac16_t)((x) < 0.999969482421875 ? ((x) >= -1 ? (x)*0x8000 : 0x8000) : 0x7FFF))
```

The input is multiplied by 32768 ($=2^{15}$). The output is limited to the range $\langle 0x8000 ; 0x7FFF \rangle$, which corresponds to $\langle -1.0 ; 1.0 \cdot 2^{-15} \rangle$.

```
#include "mlib.h"
static frac16_t f16Val;
void main(void)
{
    f16Val = FRAC16(0.736);      /* f16Val = 0.736 */
}
```

A.24 FRAC32

The **FRAC32** macro serves to convert a real number to the `frac32_t` type. Its definition is as follows:

```
#define FRAC32(x) ((frac32_t)((x) < 1 ? ((x) >= -1 ? (x)*0x80000000 : 0x80000000) : 0x7FFFFFFF))
```

The input is multiplied by 2147483648 ($=2^{31}$). The output is limited to the range $\langle 0x80000000 ; 0x7FFFFFFF \rangle$, which corresponds to $\langle -1.0 ; 1.0 \cdot 2^{-31} \rangle$.

```
#include "mlib.h"

static frac32_t f32Val;

void main(void)
{
    f32Val = FRAC32(-0.1735667);          /* f32Val = -0.1735667 */
}
```

A.25 ACC16

The **ACC16** macro serves to convert a real number to the `acc16_t` type. Its definition is as follows:

```
#define ACC16(x) ((acc16_t)((x) < 255.9921875 ? ((x) >= -256 ? (x)*0x80 : 0x8000) : 0x7FFF))
```

The input is multiplied by 128 ($=2^7$). The output is limited to the range $\langle 0x8000 ; 0x7FFF \rangle$ that corresponds to $\langle -256.0 ; 255.9921875 \rangle$.

```
#include "mlib.h"

static acc16_t a16Val;

void main(void)
{
    a16Val = ACC16(19.45627);          /* a16Val = 19.45627 */
}
```

A.26 ACC32

The **ACC32** macro serves to convert a real number to the `acc32_t` type. Its definition is as follows:

```
#define ACC32(x) ((acc32_t)((x) < 65535.999969482421875 ? ((x) >= -65536 ? (x)*0x8000 : 0x80000000) : 0x7FFFFFFF))
```

The input is multiplied by 32768 ($=2^{15}$). The output is limited to the range $\langle 0x80000000 ; 0x7FFFFFFF \rangle$, which corresponds to $\langle -65536.0 ; 65536.0 \cdot 2^{-15} \rangle$.

```
#include "mlib.h"

static acc32_t a32Val;

void main(void)
{
    a32Val = ACC32(-13.654437);          /* a32Val = -13.654437 */
}
```

How to Reach Us:

Home Page:

nxp.com

Web Support:

nxp.com/support

Information in this document is provided solely to enable system and software implementers to use Freescale products. There are no express or implied copyright licenses granted hereunder to design or fabricate any integrated circuits based on the information in this document. Freescale reserves the right to make changes without further notice to any products herein.

Freescale makes no warranty, representation, or guarantee regarding the suitability of its products for any particular purpose, nor does Freescale assume any liability arising out of the application or use of any product or circuit, and specifically disclaims any and all liability, including without limitation consequential or incidental damages. "Typical" parameters that may be provided in Freescale data sheets and/or specifications can and do vary in different applications, and actual performance may vary over time. All operating parameters, including "typicals," must be validated for each customer application by customer's technical experts. Freescale does not convey any license under its patent rights nor the rights of others. Freescale sells products pursuant to standard terms and conditions of sale, which can be found at the following address: www.freescale.com/salestermsandconditions.

Freescale and the Freescale logo are trademarks of Freescale Semiconductor, Inc. All other product or service names are the property of their respective owners.

© 2019 NXP B.V.

